

BERNARD PLIEMAN

REDACTED PERSONNEL FILE

Bernard Pleiman

Personnel File while member of the Society of Mary

born Norwood, Ohio April 10, 1917

professed in the Society of Mary August 15, 1935

dispensed from vows May, 1973

died June 14, 1986

-
1. Documents regarding entrance to the Society
 2. assignment card listing teaching assignments while a member
 3. academic transcripts
 4. correspondence regarding dispensation from perpetual vows
 5. writ of dispensation from the Vatican

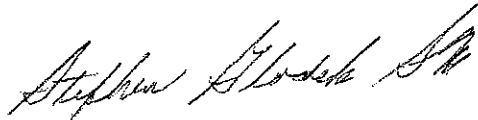

Stephen Glodek, SM

March 17, 2006

MAR-PLMN 000001

Pleimann, Bernard Thomas

GENERAL INFORMATION

NAME: Family Name *Pleimann*
 Christian Name *Bernard T*
 Father's Name *Charles*
 Mother's Name *Mary Jane*
 ADDRESS: Father *2208 Harneford Ave, Norwood, O*
 Mother
 Guardian
 BIRTH PLACE: City *Norwood*
 State *Ohio*
 DATE OF BIRTH: *April 10, 1917*
 POSTULATED: Entered at *Mt St John*
 Date of entrance *Aug 1, 1932*
 NOVITIATE: Entered at *Mt St John*
 Date of entrance *Aug 14, 1934*
 Date of leaving *Aug 16, 1935*

TEMPORARY VOWS

Place	Date	Term
<i>Mt St John</i>	<i>Aug 15, 1935</i>	<i>one year</i>
<i>" " "</i>	<i>July 11, 1934</i>	<i>" "</i>
<i>Santa Cruz, Cal.</i>	<i>July 10, 1937</i>	
<i>Honolulu, T.H.C.</i>	<i>July 31, 1938</i>	
<i>" " "</i>	<i>July 16, 1939</i>	

PERPETUAL VOWS

Place *Honolulu, T.H.C.* -S.L.C. Date *July 7, 1940*

PLACES AND EMPLOYMENT

Date	Place	Employment	Director
Aug. 16, 1935	MA St. John	Scholastic	Rev. John Rauscher
Aug. 10, 1936	S. Francisco St. John	Teacher	Bro. Peter Mauer
Aug. 9, 1937	Hilo, H. I.	"	Lawrence Clendinning
Aug. 27, 1939	Honolulu - S.L.C.	"	Bro. Paul Sibling
Aug. 20, 1940	Hono. Cath. Sch.	"	Bro. John Mastal
Aug. 19, 1941	Hono. - Cath. Sch.	Teacher	Bro. Charles Reiter
Aug. 19, 1942	Honolulu - S.L.C.	"	Bro. Paul Sibling
Aug. 3, 1945	Brook. St. J. H.	Prefect	Bro. Matt. Betz
June 28, 1946	Honolulu - S.L.C.	Teacher	Bro. Leo Rausch
Aug. 15, 1947	Hilo, T.H.	Teacher	Bro. Benedict Wengler
Aug. 21, 1948	Hilo	Teacher	Rev. Thomas Hogan
June 17, 1951	Dayton	Student	Fr. Rennecker
July, 1952	Gardena	Teacher	Rev. W. Swegar
1953	Gardena	Teacher	Brought, Rev. Donald
1956	"	"	Bro. J. Hoffman

SCHOLARSHIP

- High School Diploma
- Teacher's Elementary Certificate
- Teacher's High School Certificate
- Degrees

REMARKS

J. M. J.

PROVINCE OF CINCINNATI

Personal Information Form

Name of Religious Bro. Bernard T. Pleimann

Father's Name (if living) Charles Pleimann

Place of Birth Ft. Thomas, Kentucky

Mother's Maiden Name (if living) Mary Kreke

Place of Birth Covington, Kentucky

*Addresses of nearest of kin and degree of relationship:

Name & Relationship Mrs. Chas. Pleimann (mother)

Address 2208 Hannaford Avenue

Name & Relationship Norwood, Ohio

Address _____

Name & Relationship _____

Address _____

Name & Relationship _____

Address _____

Name & Relationship _____

Address _____

*Please inform the Provincial at once of the change in address of the nearest of kin.

reading, pleasure excursions, exist no longer for him; he shuns such disedifying crowds as vain curiosity attracts sometimes even to the church" (Const., Art.171).

7. "The Chapter decides that the Director, whilst giving the Religious his traveling money, shall also give him a written or printed note on which shall be indicated the sum given, and which the Religious shall give back at his return, properly filled out, with a detailed list of his expenses and the sum of money still remaining. This statute is applicable to all changes of residence involving expenses. The Vade Mecum is to be returned to the Provincial by the Director as soon as possible after the return of the Religious" (General Chapter of 1896, page 125. (General Chapter of 1939, pages 374 and 375).

8. It is recommended to continue the laudable custom of saying the Litany of the Blessed Virgin before each journey for the personal safety of the Religious.

Amount received upon departure	175	
Presents		
Itemized Expenses	175	
Railroad Fare ... <i>Bklyn. to D.D.</i>	83	56
Meals	15	65
Car Fare ... <i>TAXI</i>	5	85
<i>TIPS</i>	8	25 ← 8.25
<i>Souvenirs, Card, Stamps</i>	1	85
<i>Baggage, checking etc.</i>	2	34
<i>Watch Repaired</i>	70	20
<i>Misc.</i>	2	35
Total Expenses	175	275
Balance given to Director upon return	45	275
Total	175	

Aug. 26, 1946 *Leo S. Rancich, M.*
 Date of return Director

Alvius J. Seitz
 Provincial

V. M. of *Bernard Pleimann*

Vade Mecum for Traveling

* * * * *

Mount St. John, Dayton, Ohio

No. 648..

..... July 19....., 1946.

Brother Bernard Pleimann..... is hereby authorized to go
from Brooklyn..... to Cincinnati.....
from to
for the purpose of Visit home..... and to remain there

8 full days. Lodge in local community.....
According to instructions of Father Provincial.
Leave Return

* * * * *

NOTA BENE

1. "When a Religious goes to a place where the Society has an establishment, he may not lodge outside the community, not even with his parents or relatives" (Const., Art. 248). Religious are requested to notify Directors about their arrival several days in advance.

2. "Never should the lay religious consider himself a secular. If by his costume he differs less from the people of the world than the members of other Institutes, he is all the more bound to distinguish himself from seculars by a grave and modest exterior (Const., Art. 351).

3. "Mental and vocal prayers are performed preferably before the Blessed Sacrament" (Const., Art. 128). It is suggested that the Religious take with him his Formulary and a copy of the Imitation of Christ.

4. "No present is solicited; none is accepted unless for the community or for the chapel. Every personal present is refused" (Const., Art. 40).

5. "The Religious ... denies himself familiarities and every unbecoming liberty ... especially does he avoid persons of the other sex" (Const., Art. 46). "In the vigilance which he exercises over his senses and in the privations which chastity imposes he finds a source of merit and consolations" (Const., Art. 47).

6. "Mortification directs and sanctifies the use of the senses by the holiness of the intention. There is for the professed nothing beautiful, nothing agreeable or curious to see or hear solely for the purpose of procuring for himself some gratification, after the manner of the world. Worldly amusements, futile conversations, frivolous correspondence, or

J. M. J.

*For the glory of the Most Holy Trinity,
the honor of Mary, and the salvation of my
soul, I Bernard Heimann
promise to God and vow to observe during
my whole life, Poverty, Chastity, Obedience,
and Stability, conformably to the Constitu-
tions of the Society of Mary.*

Honolulu, July 7, 1940
Nazareth,

Bernard Heimann

J. M. J.

For the glory of the Most Holy Trinity,
the honor of Mary, and the salvation of my
soul, I Bernard Fleimann
promise to God and vow to observe during
one year, Poverty, Chastity and Obedience,
conformably to the Constitutions of the So-
ciety of Mary.

Honolulu, ~~St. Louis College~~ July 16 1939
~~Mount St. John,~~

Bernard Fleimann

Rev. Aloysius J. Besel, S.M.

J. M. J.

For the glory of the Most Holy Trinity,
the honor of Mary, and the salvation of my
soul, I Bernard Heimann
promise to God and vow to observe during
one year, Poverty, Chastity, and Obedience,
conformably to the Constitutions of the So-
ciety of Mary.

St. Louis College
Nazareth, Dayton, O. July 31 1938
Honolulu, Hawaii
Bro. Bernard Heimann

MAR-PLMN000009

J. M. J.

For the glory of the Most Holy Trinity,
the honor of Mary, and the salvation of
my soul, I Bernard Heimann
promise to God and vow to observe dur-
ing one year, Poverty, Chastity and
Obedience, conformably to the Constitu-
tions of the Society of Mary.

Santa Cruz
Mount St. John, July 10 1937
Bernard Heimann

June 9, 1940

Brother Bernard Pickmann,
St. Louis College,
Honolulu, T. H.

Dear Brother Bernard,

I am pleased to notify you that our Vicar-General, now our supreme authority, has given an affirmative answer to your application for perpetual vows. This is a cause of thanksgiving to God and our Blessed Mother. In this duty of gratitude I will join you.

Prepare well for the day of your total consecration of your life to God in the service of our Blessed Mother, by strict observance of our holy Rule, by the strict keeping of your religious vows, by the cultivation of the family spirit, and by fervent prayer.

Congratulations!

Very devotedly yours in J. M. J.,

MAR-PLMN 000011



Saint Mary's School

507 Waianuenue St.

Hilo, Hawaii.

May 21, 1939

Very Rev. Walter C. Fredtin, S. M.
Dear Father:

I am writing you requesting the favor of renewing my Temporary Vows for another year. With the grace of God I will make this coming year the best year of my life if you will grant my request.

My health, thank God, could not be much better. I have little trouble in the classroom, thanks to my dear Mother Mary to whom I dedicate each one under whose guidance and care I place myself and my boys.

Begging you to allow me to renew my vows, I remain

Your obedient servant
in J. M. J.

Brother Bernard Pleiman

J. M. J.
MOUNT SAINT JOHN

R. 12 - BOX 71

DAYTON, O

May 21, 1935

Very Rev. Joseph Tetzlaff, Provincial
Rev. Father Provincial.

Since the time of my probation is almost up, I must beg of you to admit me to the first profession of the three vows of religion. I believe that this is the greatest grace God could bestow after that of Baptism. I know I do not of my own dispositions merit this great gift. I beg of you to forgive and forget my defects, both physical and spiritual, which, I hope, are the only obstacles standing between me and the profession of vows. I feel that God has called me to the Society of Mary

MAR-PLMN000013

and with His grace and your permission I hope to be permitted to take vows and then, the grace to persevere in my calling. I have chosen this Society to any other because it is consecrated in an especial manner to my dear Mother Mary and also because in it I believe I can work out my own salvation and salvation of others.

If I have the good fortune to be admitted, I also ask another favor, namely, of becoming a Teaching Brother, but I resign myself to your decision. I know that God in His Divine Providence did not give me "ten talents" but I, like the other servants mentioned in the Gospel, will try to double what He has given me.

MOUNT SAINT JOHN

R. 12 — BOX 71

DAYTON, O

My Confessor has given
me the permission to make vows.

As regards to going to
the Islands or to any mission
country I would gladly go at any
time, for in the eyes of Faith,
the Superior's will is God's will.

I remain

Your obedient Novice

Bernard Pleimann

Renseignements relatifs aux voeux perpetuels

Demandés par M. Bernard Fleimann de St. Louis College,
Honolulu, T. H.
Né le April 10th, 1917
Premiers voeux le August 15th, 1935
Demandes antérieures en en en

Voix de la communauté { Pour: 45
Contre: 5
Ne se prononcent pas: 3

Principales observations pour: Steady, even, agreeable character; faithful to religious exercises and class work; regular in rising successful in his work; has fairly good judgment; dealings with Superiors good; has family spirit; ready to help in the work of the community; employs time fairly well; good religious and devoted teacher. Seems to know what he is doing; not ostentatious. Has the spirit of charity; good character and seems to be satisfactory in his dealings with superiors, fellow-Brothers, pupils, etc.

Principales observations contre: Childish at times; silence could be improved; one religious writes: "Gloomy, other lengthily melancholic; inclined to impudence in his dealings with fellow-Brothers; too self-centered too much reading novels." Slightly flighty; somewhat of a trifler. Rather drowsy during prayers. Another religious writes: "Inclined to be very headstrong which at times should not go un-

Voix du Conseil { Pour: 5
du Provincial Contre: 0
Ne se prononcent pas:

Principales observations pour: A steady, faithful religious; his general conduct shows the proper spirit; the defects quoted above will be overcome in time. He is sincere.

Principales observations contre:

Avis du Conseil du Provincial:

Observations, s'il y a lieu:

MOUNT ST. JOHN, 1e 27 mars 1940

Le Provincial

noticed. I believe more effort could be made to stay awake during meditation. I believe that he has the necessary qualifications." Another writes: "Health seems good, but his hearing is rather poor for a young man. I think the doctor should be consulted on the seriousness of this defect. Should he soon become deaf, he would be a burden for years." Another: "Too easily provoked to anger, regardless of persons involved." Another: "Due to inexperience lacks religious seriousness. Makes poor decisions. Needs firmer judgment." Another: "Needs more of an adult outlook on life. His first year at St. Louis is too much of a contrast to that of St. Mary's, Hilo. Favor one year delay to study tendencies towards cliques."

J. M. J.

Destination des Sujets (Const. art. 335-336).

M. Pleiman, Bernard Thomas
 Né à *Horwood, O.* le *10 avril* 19*17*.
 Entré au Postulat de *Mt. St. Jean* le *10 août* 19*32*.
 Classement final sur postulants de (1)
 Entré au Novicat de *Mt. St. Jean* le *14 août* 19*34*.

Observations générales des bulletins du Noviciat:
 1er trimestre *Ce novice est très sérieux, il est docile, mais n'est pas bien doué. Il se conduit bien et est ass. studieux.*
 2e trimestre *Il continue à bien se conduire. Sa tenue est quelquefois un peu lâche dans ses vêtements. Il prend bien les remarques.*
 3e trimestre

Classement du dernier examen: *16* sur *24* novices.

Rémarques spéciales concernant:

- La famille, la première éducation, l'origine de la vocation;
- La santé, l'intelligence, le caractère, l'esprit religieux;
- Les aptitudes, les attrait du sujet.

*La famille est bonne, bien formée.
 Il a reçu sa première éducation des sœurs
 et a fait deux ans de High School à Farrell.
 Son caractère est sociable. Intelligence bien
 ordinaire. Santé bonne.*

(1) Désigner la classe.

Avis du Conseil du noviciat

1. Touchant l'admission aux vœux *Le Conseil est en faveur de ses vœux.*
2. Touchant la destination du sujet *Il devra devenir frère enseignant dans une maison pour hommes.*

Fait à Nivelles le 25 mai 1935

LE MAÎTRE DES NOVICES,

Geo Mege

Avis du Conseil du Provincial :

1. Touchant l'admission aux vœux *L'admettre. Il est un bon sujet très bien disposé et travailleur.*
2. Touchant la destination du sujet *frère enseignant.*

Fait à Nivelles le 6 juin 1935

LE PROVINCIAL,

Jos H. Letzloff S.J.

Decision de l'Administration générale

Touchant la destination du sujet *laïque enseignant*

Fait à Nivelles, le 6 juillet 1935

Jung
ch

J. M. J.

Novitiat de

St. John

Bulletin du 1^{er} (1)

July 1935

M. (2) *Plein au Bernard* né le *April 10* 1917

à *Woodwood, O.* dép^t d

Entré au postulat le *Aug. 12* 1932

A commencé son noviciat le *Aug. 14* 1934

Notes générales

Constitution	<i>fair</i>	Application à l'étude	<i>good</i>
Taille	<i>1.77</i>	Esprit de foi	<i>seems good</i>
Santé	<i>good</i>	Id. d'obéissance	<i>good</i>
Extérieur, tenue	<i>orderly</i>	Id. de pauvreté	"
Politesse	<i>good</i>	Id. d'abégation	"
Jugement	<i>correct</i>	Id. de charité	<i>frassome</i>
Caractère	<i>docile</i>	Id. de famille	" "
Attach. à la vocation	<i>seems good</i>	Docilité à la correction	<i>yes</i>
Ouverture	<i>frank</i>	Facultés saillantes	<i>orderly</i>
Piété	<i>good</i>	Aptitudes particulières	" "
Régularité	"	Défauts saillants	<i>nothing particular</i>
Silence	"		

Enseignement	Notes	Places	Enseignement	Notes	Places
Doctrne chrétienne	<i>9</i>		Marialogie	<i>7</i>	
Vie intérieure	<i>8</i>		Histoire sainte et ecclés	<i>7 1/2</i>	
Catéchisme religieux	<i>8</i>		Pédagogie	<i>7</i>	
Constitutions	<i>7</i>		Ecriture	<i>9</i>	
Oraison	<i>9 1/2</i>		Chant	<i>8</i>	
Evangile	<i>9</i>		<i>drawing</i>		

Place moyenne de l'examen : *18* sur *21* novices { *lettrés* (3) / *ouvriers* }

Observations spéciales :

Appréciation générale du sujet : *This candidate shows good will, he applies himself well to studies. He is not lacking piety*

Le Maître des novices,
Geo. Meyer

(1) Janvier, avril, juillet. — (2) Nom, puis prénom usuel. — (3) Biffer l'un des deux mots.

J. M. J.

Noviciat de M. St. John

Bulletin du 1^{er} (1) April 1935

M. (2) Pleiman Bernard né le April 10 1917

à Woodward, O. dépt d.

Entré au postulat le Aug. 1^{er} 1933

A commencé son noviciat le Aug. 1^{er} 1934

Notes générales

Constitution.	<u>strong</u>	Application à l'étude.	<u>good</u>
Taille	<u>177</u>	Esprit de foi	<u>seems fair</u>
Santé	<u>good</u>	Id. d'obéissance	<u>good</u>
Extérieur, tenue	<u>ordinary</u>	Id. de pauvreté.	<u>"</u>
Politesse.	<u>good</u>	Id. d'abnégation	<u>"</u>
Jugement	<u>correct</u>	Id. de charité	<u>"</u>
Caractère	<u>decided</u>	Id. de famille	<u>has some</u>
Attach. à la vocation	<u>seems good</u>	Docilité à la correction.	<u>yes</u>
Ouverture	<u>frank</u>	Facultés saillantes.	<u>none</u>
Piété.	<u>ordinary</u>	Aptitudes particulières.	<u>ordinary</u>
Régularité	<u>good</u>	Défauts saillants	<u>nothing special</u>
Silence	<u>frankly "</u>		

Enseignement	Notes	Places	Enseignement	Notes	Places
Doctrines chrétienne	<u>8</u>		Marialogie	<u>8</u>	
Vie intérieure	<u>8</u>		Histoire sainte et ecclés.	<u>8</u>	
Catéchisme religieux	<u>8 1/2</u>		Pédagogie		
Constitutions	<u>9</u>		Ecriture	<u>7</u>	
Oraison.	<u>8</u>		Chant	<u>7</u>	
Évangile	<u>8</u>		<u>Divinity</u>	<u>9</u>	
	<u>6</u>		<u>Ecology</u>	<u>9</u>	
Place moyenne de l'examen : <u>16</u>			sur <u>24</u> novices } <u>lettrés</u> (3)		
			} <u>ouvriers</u> (3)		

Observations spéciales :

Appréciation générale du sujet : This novice is ordinary, he is not very talented. Sometimes lacks seriousness, but shows fair spirit.

Le Maître des novices,
Geo. Meyer

(1) Janvier, avril, juillet. — (2) Nom, puis prénom usuel. — (3) Biffer l'un des deux mots.

J. M. J.

Noviciat de St John

Bulletin du 1^{er} (1) Jan'y 1 1935

M. (2) Reiman Bernard né le April 10 1927

à Newwood O. dépt d

Entré au postulat le Aug. 1st 1932

A commencé son noviciat le Aug. 14 1934

Notes générales

Constitution.	<u>strong</u>	Application à l'étude	<u>fair</u>
Taille	<u>1m 76</u>	Espit de foi	<u>seems good</u>
Santé	<u>good</u>	Id. d'obéissance	<u>good</u>
Extérieur, tenae	<u>ordinary</u>	Id. de pauvreté.	"
Politesse.	<u>good</u>	Id. d'abnégation	"
Jugement	<u>fair</u>	Id. de charité	"
Caractère	<u>somewhat childish</u>	Id. de famille	<u>has some</u>
Attach. à la vocation	<u>seems good</u>	Docilité à la correction.	<u>yes</u>
Ouverture	<u>frank</u>	Facultés saillantes	<u>None</u>
Piété.	<u>ordinary</u>	Aptitudes particulières.	<u>ordinary</u>
Régularité	<u>good</u>	Défauts saillants	<u>nothing</u>
Silence	<u>fair</u>		<u>special</u>

Enseignement	Notes	Places	Enseignement	Notes	Places
Doctrine chrétienne	<u>8 1/2</u>		Marialogie	<u>7 1/2</u>	
Vie intérieure	<u>7 1/2</u>		Histoire sainte et scolés.	<u>8</u>	
Catéchisme religieux	<u>8</u>		Pédagogie		
Constitutions	<u>6</u>		Ecriture	<u>7</u>	
Oraison.	<u>8</u>		Chant	<u>8</u>	
Evangile	<u>8</u>		<u>drawing</u>	<u>8</u>	
	<u>Latin</u>		<u>liturgy</u>	<u>7</u>	

Place moyenne de l'examen : 20 sur 24 novices } lettres ouïriers (3)

Observations spéciales :

Appréciation générale du sujet : ordinary novice. He is docile, fairly pious & a steady study holder.

Le Maître des novices,
Geo. Meyer

(1) Janvier, avril, juillet. — (2) Nom, puis prénom usuel. — (3) Biffer l'un des deux mots.

Name	Bernard Thomas Plimann
Father's Name	Charles Plimann
Mother's "	Mary Sauer
Address	2208 Hannaford Ave
City & State	Worwood Ohio
Born	✓ April 10, 1917
Baptism	April 15, 1917
Confirmation	Nov. 16, 1924
Date of Entrance	Aug 1, 1932

MOUNT SAINT JOHN NOVITIATE

R. D. NO. 12 -- BOX 71

Dayton, O., *May - 15 - 1934*

CANONICAL INFORMATION REGARDING

Bernard Pleinan

Born *April 10th 1917*

at *Norwood, Ohio*

Archdiocese or ~~Diocese~~ *of Cincinnati*

Son of *Charles Pleinan*

and *Mary Sauer*

Please furnish information on the following points concerning the above named applicant

- 1. Birth
- 2. Conduct
- 3. Character
- 4. Life
- 5. Reputation
- 6. Social Status
- 7. Learning
- 8. Canonical Impediments
- 9. Financial Obligations
- 10. Other Personal Obligations and Responsibilities
- 11. Other points mentioned in Canons 544 and 545 of the New Code

Very Good as far as I know

Date *May 17 - 1934*

Signature *Henry A. Ruse*

OMNIBUS HAS LITTERAS VISURIS
SALUTEM IN DOMINO

Cum dilectus in Christo filius *Bernardus Pleinan*
filius leg *itimus Caroli Pleinan*
ejusque uxoris, *Mariae Sauer*
natus die *11^{te}* mensis *Aprilis* anno *1917*
in parochia *S^{an}c^ti Petri & Pauli Norwood* diocesis *Cincinnatiensis*
in Societatem B. V. Mariae admitti intendat:

Hisce litteris juxta scientiam Nostram ex diligenti investigatione, ad tenorem C. 545,
deductam, testamur:

Nihil in aspirantis natalibus, moribus, ingenio, vita, fama, conditione, scientia, obstare
quominus supradictam Societatem ingredi valeat, ipsum nullo modo esse inquisitum, alicui
censuræ, irregularitati aut alio canonico impedimento irretitum; neque propriam familiam
ejus auxilio indigere.

Datum in Urbe Nostra *Cincinnatiensis*, *archi* episcopali,

die *29* mensis *Juni* A. D. *1934*.

By Mandate etc
Josephus N. Albers
Episcopus Arch. Cincinnatiensis

Certificate of Confirmation

The Records of this Church Certify, under date of Nov 16 1924
that Bernard Pleiman SON
DAUGHTER
of Charles Pleiman and Mary Sauer,
born Apr 10 1917, and baptised April 15 1917,
in S. S Peter & Paul Church, located Norwood Ohio,
was Confirmed by the Most Rev. Archbishop Moeller D.D.
with Sponsor Earl Pleiman.

Rev.

Date

Henry H Duse
July 2 1932

SEAL OF
CHURCH

A. J. EGGERS & CO., PRINT. CINCINNATI, O.

Baptismal



Certificate

The Records of this Church Certify, under date of Apr. 15 1917
to the Baptism of Bernard P. Pleiman, born Apr 10 1917
of Charles Pleiman and Mary Sauer.

Said Record is signed by Rev. Bernard J. Beckmeyer
with sponsors John Sudkamp and Almas Sauer.

Rev.

Date,

Henry H Duse
July 2, 1937

CHURCH SEAL
HERE

EGGERS & CO., PRINT. CINCINNATI

MAR-PLMN 000026

St. Anthony's Church,

Rev. F. M. Kehoe, Pastor.

Bellevue, Ky., February 2 1916

This is to certify that on the 6th of February, a. d. 1916
Charles Pleimann of Cincinnati, Ohio, and Mary Laner
of Bellevue, Ky. were united in the bonds of matrimony
by Rev. Thomas M. Grady, at Bellevue, Ky., in the presence
of Gus Laner, Jr. and Helen Laner

Rev. Francis A. Kehoe, Pastor,

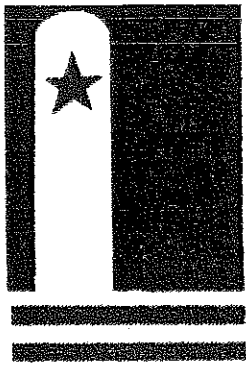

MARIANIST PROVINCIAL RESIDENCE

April 11, 1973

Reverend Vincent Vasey, S.M.
Marianisti
Via Latina 22
00179 Rome, ITALY

Dear Father Vasey,

I am sending to you the original copy of my letter to Father Tutas and the original copy of the letter of Brother Bernard Pleimann in which he requests a dispensation from his perpetual vows. I am doing this, so that you can act upon this immediately, if that is your agreement with the General Administration.

I am sending carbon copies of all this material to Father Tutas, and I am sending it directly to the General Administration and not to Africa.

At the present I do not know of any other religious in the Province with perpetual vows who are thinking of asking for a dispensation. This is good news, and I hope that I am not too optimistic, for the end of the school year has not yet come nor have we gone through the summer. However at present it seems that only a couple of temporary professed will be asking not to renew their vows this summer. It looks, therefore, as though our perseverance rate this year will be good. I hope this is so and such is our prayer.

Presently we have already approved four for the novitiate for next year. There is a possibility of one or the other besides these four. This is also good for us.

Reverend Vincent Vasey, S.M.

Page 2

April 11, 1973

Thanks for all you are doing for us. You are in our prayers.

Sincerely yours in J. M. J.,

Bertrand Clemens, S.M.

Very Rev. Bertrand E. Clemens, S.M.

Enclosures

P. S. I am wondering if the Sacred Congregation is still working on the laicization of Father Peter Choo. You will remember that we submitted a request for a laicization of Pete Choo without his knowledge of this. I am wondering what might be the status in his case at this time. Thanks for any information you can give us in this regard.

Bert Clemens, S.M.

MAR-PLMN 000030

C O P Y

April 11, 1973

Brother Bernard Pleimann, S. M.
St. Joseph College
Nakaku, Yamate 85
Yokohama, JAPAN

Dear Barney,

I have received your letter in which you requested a dispensation from your perpetual vows. I have forwarded your letter to the General Administration, and asked that they petition Rome that you be dispensed from your perpetual vows. As soon as I receive any information from Rome, I will contact you.

Certainly I am sorry that you are asking for this dispensation. However, Brother Roger mentioned that you did not want to be dissuaded from seeking the dispensation, so we have proceeded with requesting your dispensation from the Sacred Congregation.

I do hope that all will go well with you during the remainder of this year, and that you will begin to make plans for your future life, so that when the dispensation arrives, you will be able to adjust easily to the lay life. Be assured you are in our prayers. May your Easter be a blessed and joyous one.

Sincerely yours in J. M. J. .

Very Rev. Bertrand E. Clemens, S. M.

MAR-PLMN 000031

C O P Y

May 30, 1973

Brother Bernard Fleimann, S. M.
St. Joseph College
Nakaku, Yamate 85
Yokohama, JAPAN

Dear Barney,

The document containing your dispensation from your perpetual vows arrived and I am enclosing it with this letter.

As soon as you have received this document, you have ten days to decide if you want to accept the dispensation. When you receive this document, if you are still definitely determined to leave the Society of Mary, I would advise that you sign the enclosed return postcard to me immediately. As soon as you sign this postcard, your vows are dispensed.

If you are not clearly determined to leave the Society when you receive this document, I would advise that you endeavor as soon as possible to arrive at a decision through prayer and consultation. You have ten days in which to do this. If after ten days, you have not signed the enclosed postcard, your vows remain in effect and you are a Marianist in good standing. Later on then, if you would ever again decide to leave the Society of Mary, you would need begin again to request a dispensation. As I mentioned above, if you are still definitely determined to leave the Society when this document arrives, then sign the postcard immediately and your vows are no longer in existence. We would appreciate you returning the card in this case to us at once.

I hope all is going well with you, and that the school year is coming to a successful completion for you. I understand from Brother Roger that you might be teaching at St. Joseph's next year as a layman if you accept

MAR-PLMN 000032

C O P Y

Brother Bernard Pleimann, S. M.

Page 2

May 30, 1973

your dispensation. Please do drop me a note and let me know your plans, for I am most interested in you and in your plans. I hope that everything has been thought through very carefully in regard to yourself and your plans.

If I can be of any further help to you, do let me know. You are in my prayers. God bless you!

Sincerely yours in J. M. J.,

Very Rev. Bertrand E. Clemens, S. M.

Enclosures

MAR-PLMN 000033



SACRA CONGREGATIO
PRO RELIGIOSIS
ET INSTITUTIS SAECULARIBUS

N. 17539/73

BEATISSIME PATER,

..... Frater Bernardus PLEIMANN,
professus a votis simplicibus perpetuis in Societate Mariae (Marianista-
rum),

cum ad onera vitae religiosae sustinenda se imparem sentiat, a Sanctitate Tua humil-
lime implorat indultum saecularizationis, ut in saeculum libere et legitime redire
valeat, ob rationes allatas.

Et Deus, etc.

Vigore facultatum a Summo Pontifice concessarum, Sacra Congregatio pro
Religiosis et Institutis saecularibus annuit pro gratia, iuxta preces, ita ut Orator,
deposita exteriori forma habitus religiosi, solutus a votis ceterisque obligationibus
suae Professionis, a sua Religione separatus maneat.

Praesens rescriptum nullius roboris esto si ab Oratore non fuerit acceptatum
infra decem dies ab eiusdem recepta communicatione.

Contrariis quibuslibet non obstantibus.

Datum Romae, die 15. maii 1973.

*Basilius Heiser, Op. Cuv.
Subsecretarius*

I have received the document from Rome.

6/6/73

(date received)

6/14/73

(date accepted)

Bernard Pleimann

(signature)

..... Frater Bernardus PLEIMANN,

..... professus a votis simplicibus perpetuis in Societate Mariae (Marianista-
rum),

..... cum ad onera vitae religiosae sustinenda se imparem sentiat, a Sanctitate Tua humil-
lime implorat indultum saecularizationis, ut in saeculum libere et legitime redire
valeat, ob rationes allatas.

Et Deus, etc.

Vigore facultatum a Summo Pontifice concessarum, Sacra Congregatio pro
Religiosis et Institutis saecularibus annuit pro gratia, iuxta preces, ita ut Orator,
deposita exteriori forma habitus religiosi, solutus a votis ceterisque obligationibus
suae Professionis, a sua Religione separatus maneat.

Praesens rescriptum nullius roboris esto si ab Oratore non fuerit acceptatum
infra decem dies ab eiusdem recepta communicatione.

Contrariis quibuslibet non obstantibus.

Datum Romae, die 15 maii 1973.

Basilius Meiser, O.P.M. Cuv.
Subsecretarius

P. A. Minich, P.A.

NAME PLEIMANN Bernard Thomas of the Diocese of Cincinnati
 (Family Name) (Christian Name)

GENERAL INFORMATION

Father's Name Charles Pleimann (RIP) Address _____
 Mother's Name Mary Kreke Sauer (RIP) Address 1220 Webster Ave Deer Park Cincinnati Ohio
 Guardians's Name CLIFF PLEIMANN Address 1933 CORDOVA AVENUE
BROTHER N. COLLEGE HILL, CIN OH
 Entered Postulate at Mt St John Date of Entrance 8/1/32
 Entered Novitiate at Mt St John Date of Entrance 8/14/34

Temporary Vows		
Place	Date	Term
Mt St John	8/15/35	1 yr
" "	7/11/36	1 yr
Santa Cruz	7/19/37	1 yr
Hono-SLHS	7/31/38	1 yr
" "	7/16/39	1 yr

Province of the Pacific

Birth Place Norwood Ohio Date 4/10/17
 (City) (State)
 Baptism Place Norwood Ohio Date 4/15/17
 (City) (State)
 Confirmation Place Norwood Ohio Date 11/16/24
 (City) (State)
 Perpetual Vows Place Honolulu Hawaii Date 7/7/40
 (City) (State)
 Ordination Place _____ Date _____
 (City) (State)
 Death Place _____ Date _____
 (City) (State)
 Withdrawal Place Yokohama St. Joseph T (P) Date 5/73
 (City) (Establishment)

NAME PLEIMANN Bernard Thomas

Name Bernard T. Pleimann
 Date and Place of Birth April 10, 1917 Norwood, Ohio
 Date and Place of First Profession Aug. 15, 1935 Mt. St. John
 Date and Place of Perpetual Profession July 1940 St. Louis College
 Date of Arrival in Hawaii Aug. 26, 1937 Aug. 26, 1946

Names and Addresses

Mrs. C. Pleimann 2208 Hannaford Ave.
Norwood, Ohio
4220 Webster Ave. Deer Park,
Cincinnati, 36, OHIO

Places of Teaching and Year
 Mark the year double 1883-84

<u>1936 - 37</u>	<u>St. James San Francisco</u>
<u>1937 - 39</u>	<u>St. Marys Hills</u>
<u>1939 - 40</u>	<u>St. Louis College Honolulu</u>
<u>1940 - 42</u>	<u>Cathedral School</u>
<u>1942 - 45</u>	<u>St. Louis College</u>
<u>1945 - 46</u>	<u>St. Johns (Hawaii)</u>
<u>1946 -</u>	<u>St. Louis College</u>

Oleimann, Bro. Bernard J.

Bernard, Bro.

Born April 10, 1917 First Vows Aug. 15, 1935 Perpetual Vows July 7, 1940 Came to Hawaii Aug. 26, 1937
II Aug. 26, 1947

Year	Class or Occupation	Year	Class or Occupation
1939-40	Grade 4-A. Flag		
— —	— Cathedral Sch., Hon. —		
1942-43	Grade 6-C.		
1943-44	Grade 6-B.		
1944-45	Grade 7-C.		
— —	To St. John's Home, Brooklyn		
1946-47	Grade 5-A.		
— —	To Hilo		
1951...	Dayton		
1952-1962	Gardena		
1962 -			

University of Dayton

DAYTON, OHIO

OFFICE OF THE REGISTRAR April 29, 1949

Official Transcript of the Record of Bro. Bernard Pleimann, S.M.

Address _____

Date	Course No.	DESCRIPTION	Sem. Hrs.	Grade
HONOLULU SUMMER SCHOOL - 1939				
	Ger. 101	Elementary German	3	B
	Psych. 201	Introductory Psychology	3	B
1939-40	301	U. S. History 1492-1852	3	B
	312	Logic	2	B
S-1940	201	Introductory Psychology	3	C
	201	Principles of Economics	3	C
2/1/41		Logic	1	D
1940-41	303	Human Physiology	(3)	aud.
	106	Analytical Geometry	(3)	aud.
S-1941	Art 201	Principles of Design	2	A
S-1942	Math. 201	Differential & Integral Calculus	4	B
	G.E. 101	Engineering Drawing	3	C
S-1944	Educ. 410	Seminar in Teaching of Religion	2	B

3000-8-10-46

Elmer C. Lackner, M.A.
Registrar.

MAR-PLMN 000040

ACADEMIC RECORD
GRADUATE

Name _____ Degree B.S. IN ED.
 Date 1952 Degree H.D.
 Date _____ Degree _____

Date	University	Subject	Cr. Hr.	Grade
1953	South. Cal.	Sec. Math from Advanced Standpoint	3	B
1954-8	South. Cal.	Theory of Numbers	3	B
1954-55	South. Cal. 435	Vector Analysis	3	B
		Higher Math for Physicists & Engineers	(3)	F
1953 S	USC 455	FOUNDATION MATH	5	A
1956	LOYOLA ED 265	GUIDANCE	3	B
1958 S	U. OF CHI. (NSF)	MATH 296 S	3 1/3	B
		297 S	3 1/3	B
1959 S	U. OF ARIZONA	SC. + MATH (N.S.F.)	7	A
1959-60	LOYOLA U.	EXCER. CHILDREN	3	A
5 1960	SEERRA	TEACH - SS		D
5 1961	U. OF ARIZONA	SUMMER INST. (N.S.F.)	4-4	B+ A
5 1962	ST. LOUIS HS, HONOLULU	TEACHING		
SS 1963	ARIZONA, U.	NSF GRANT		

Society of Mary

PERSONNEL RECORD

Province of the Pacific

Name Pleimann, Bernard M. Thomas

Date of Birth APR. 10, 1917 City Norwood State Ohio

Home Address in Case of Emergency: Mrs. Maryes Pleimann, (Mother) 4220 Webster, Deer Park, Cincinnati, Ohio

Entered Postulate— at Mount St. John Aug. 1, 1932

Entered Novitiate _____ Aug. 1, 1934

First Vows _____ Aug. 15, 1935

Perpetual Vows _____ July, 1940

Date	City	School	Class
1936-37	SanFrancis.	St. James	4 Gr.
1937-39	Hilo	St. Mary	4 Gr.
1939-40	Honolulu	St. Louis College	
1940-42	Honolulu	Cathed. Sch.	
1942-45	Honolulu	St. Louis College	
1945-46	Brooklyn	St. John's Home	
1946-47	Honolulu	St. Louis College	
1947-51	Hilo	St. Mary	
1951-52	Dayton	Univ. of Dayton	Student
1952-52	San Francisco	Riordan	Student
1952-52	Gardena	Gerra H. S.	
1952	Honolulu	St. Louis	

UNIVERSITY OF DAYTON
DAYTON, OHIO
OFFICE OF THE REGISTRAR

Date: June 2, 1952

Name PLEIMANN, (Brother) Bernard Thomas, S.M.

Date of Birth 4-10-17

Address 175 Phelan Avenue City San Francisco 12 State California

Your application for admission together with your transcript of credits from _____ has been received.

ENTRANCE CREDITS:

Graduated _____

SUBJECTS		UNITS		SUBJECTS		UNITS		SUBJECTS		UNITS	
English		Economics		Gen. Science		Phys. Geography		Com. Law			
Latin		Sociology		Chemistry		Agriculture					
French		Algebra, Elementary		Physics		Bookkeeping					
German		Algebra, Advanced		Biology		Stenography					
Spanish		Geometry, Plane		Botany		Typewriting					
History		Geometry, Solid		Zoology		Com. Arithmetic					
Civics		Trigonometry, Plane		Physiology		Com. Geography		Total			

Advanced standing:

Acceptable credits from:

University of San Francisco:

1951-1952	Math. 108	History of Mathematics	2	A
2nd. Semester	Math. 115	Modern Trends in Higher Algebra	3	B
	Educ. 111	Child Growth & Development	2	B
	Educ. 125	Audio-Visual Techniques	2	A
	Educ. 245	Seminar in Secondary Curriculum	2	A

11 Semester Hours

Please add these credits to the record of Brother Pleimann, student in the Division of Education.

Your academic standing will be

Sincerely,

Charles J. Collins, S.M.
Dean and Registrar

UNIVERSITY OF DAYTON

COLLEGE OF

Sept. 1934

Entered

B. S.

Degree

James, 1932

Home Address Mt. St. John, Dayton, Ohio.

OFFICE OF THE Inspector

Date

James, 1932

DEPARTMENT	Course No.	DESCRIPTIVE TITLE	1st Sem.		2nd Sem.		DEPARTMENT	Course No.	DESCRIPTIVE TITLE	1st Sem.		2nd Sem.	
			Hrs.	Gr.	Hrs.	Gr.				Hrs.	Gr.	Hrs.	Gr.
1934-35	Eng. 101,102	English	2	B	2	B	1948-S	SLC	THIRD YEAR	3	B		
	Lat. 101,102	Latin	2	B	2	B	Eng. 423	423	Tragedies of Shakespeare	3	B		
	Hist. 203	History	3	B	3	B	1944-S	SLC	Sem. in Teaching Religion	2	B		
	Ethics 303	Ethics	2	B	2	B	1949-S	SLC					
	Edu. 201	Education	2	B	2	B	Edu.	411	Teaching Science in HS.	3	A		
		Sec. Scripture	2	B	-	-	1951 - 1952	Univ of Dayton					
		Drawing	2	B	-	-	Educ	202	Educ. Psy.	3	A		
		Apologetics	2	B	-	-	Edu	307	Prin. of Teach.	3	A		
	Apolog. 201,202	Apologetics	-	-	2	B	Psy	305	Mental Hygiene	3	B		
	Dogma 101,102	Dogma	-	-	2	B	Psy	206	Gen. Physics Lecture	3	B		
		Music	-	-	2	B	Bio	101	Gen. Biology Lecture	1	A		
1935-36	Eng. 101,302	English	3	B	3	B	Math	201	Diff & Int Calculus	1	B		
	Germ. 201,202	German	3	B	3	B				1	B		
	Hist. 204	History, Modern	2	B	2	B				2	B		
	Math 103	Trigonometry	4	A	-	-				3	A		
	Chem. 101,102	Chemistry, Gen.	3	C	3	B				3	B		
	Edu. 303	Education, Org. & Mgm.	2	B	-	-				1	A		
	Edu. 304	Education, Tests & Meas.	2	B	-	-				2	B		
	Math. 104	Analytic Geometry	-	-	4	B				1	B		
1939 Summer		SECOND YEAR											
St. Louis C.	Germ. 201	Elementary German	3	B			1952	1953	FOURTH YEAR				
F.H.	Phil. 201	Psychology, Introd.	3	B			El Camino	4A	Integral Calculus	3			
1938-39	Math	Algebra	6	B									
1939-40	Hist. 301	U S Hist. 1492-1852	3	B									
U D and	Phil. 312	Logic	2	B									
St. L. C.			3	C									
1940 Summer	Phil. 201	Introd. Psychology	3	C									
U D and	Econ. 201	Prin. of Economics	3	C									
St. L. C.			3	C									
1941-S	Art 201	Principles of Design	2	A									
St. L. C.	Math 107-8	Algebra	6	A									
1941-42	Phil. 312	Logic	1	D									
St. L. C.			-	-									
1942-S	Math. 201	Diff. & Integr. Calculus	4	B									
	G. E. 101	Engineering Drawing	3	C									

MAR-PLA 00045

REGISTRATION RECORD

Graduated from
Mt. St. John Normal
Prep.
Dayton, Ohio.
1934

ENTRANCE CREDITS

English: 3

History, Civics:
American 2

Mathematics:
Algebra 1 1/2
Geometry 1 1/2

Science:
Chemistry 1
Physics 1

Languages:
Latin 3
German 2

Other Topics:

CONDITIONS

Name Pleimann, Bernard F. S.M.
Address
Date of Birth Apr. 10, 1917 Town State

Church Affiliation

Father's Name

Mother's Name before Marriage

Withdrew

Re-entered

Transcript of Record sent to:

- 1.
- 2.
- 3.

Has Honorable Dismissal

Distinction in Graduation

OTHER MEMORANDA
Religion Marks
1940 Sacred History C.B.
1941 Eccles. History B
1943 Summa Vol. I 70
1944 Summa Vol. II-1 72

MARKING SYSTEM

- A—Excellent 3 points*
- B—Good 2 points
- C—Average 1 point
- D—Poor, but Passing 0 point
- E—Conditioned 0 point
- F—Failed 0 point
- I—Incomplete 0 point

* For each semester hour allowed for the course.

CUMULATIVE HOURS AND POINTS

YEAR	1st Semester		2nd Semester		Total		Point Average
	Hours	Points	Hours	Points	Hours	Points	

MAR 19 1944

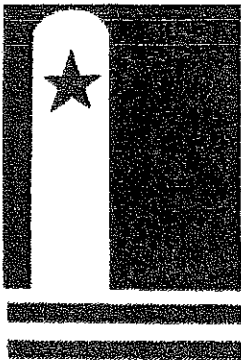

MARIANIST PROVINCIAL RESIDENCE

April 11, 1973

Very Rev. Stephen Tutas, S.M.
Marianisti
Via Latina 22
00179 Rome, ITALY

Dear Father Tutas:

I am enclosing with this letter the correspondence of Brother Bernard Pleimann addressed to Pope Paul VI in which Brother Pleimann asks for a dispensation from his perpetual vows of poverty, chastity, obedience and stability.

As Brother Pleimann indicates in his letter to His Holiness, Pope Paul VI, he was professed in the Society of Mary in 1935. Because Brother Pleimann is already in his middle fifties, we have endeavored to dissuade him from seeking a dispensation. Several years ago, Brother Pleimann wanted to ask for a dispensation, and I at that time dissuaded him. On this occasion when he first wrote to me telling me about his intention to seek a dispensation, I asked Brother Roger Richter, the Assistant Provincial, who was going to visit Japan to talk to Brother Pleimann about this. Brother Pleimann does not want to be dissuaded from seeking a dispensation at this time.

I have consulted with members of the Provincial Council, and we agree that we should send to you this letter of Brother Pleimann asking for a dispensation.

Brother Richter, the Assistant Provincial, upon his visit to Yokohama learned from the members of the religious community in which Brother Pleimann is presently living, that Brother Pleimann is drinking liquor quite heavily and is frequently intoxicated. He has been visiting saloons and has been seeing in the presence of women, which has been disconcerting for the religious community. I do not believe, from what I know of

Very Rev. Stephen Tutas, S.M.

Page 2

April 11, 1973

Brother Pleimann, that he has a strong enough faith to sustain religious life. Because Brother Pleimann does not wish to be dissuaded from seeking a dispensation and because of the evident scandal that he can now already be giving, we urge that a dispensation be sought for Brother Pleimann. I know that this is not the first time that Brother Pleimann has had the desire to leave religious life.

Thank you very much for your consideration of this request. Be assured of our prayers.

Sincerely yours in J. M. J. .

Bertrand E. Clemens, S.M.

Very Rev. Bertrand E. Clemens, S.M.
Provincial Superior

Enclosure

MAR-PLM 000048

85 YAMATE-CHO, NAKA-KU,
YOKOHAMA, JAPAN
TEL. (045) 641-0065/6
〒 231

St. Joseph College

セント・ジョセフ・カレッジ

横浜市中区山手町85番地
電話 (045) 641-0065/6
郵便番号 231

Your Holiness Pope Paul VI

April 2, 1973

I, Bernard T. Pleimann, have been a member of the Society of Mary (Marianists) since my first vows in August 1935. I took my final vows in June 1940. Presently, I am 55 years of age.

I am asking for dispensation of my vows of poverty, celibacy & obedience. My problem is one of faith. More than 20 years ago I realized I did not truly believe in all of the Church's teaching. I had lost faith in all religions. The provincial to whom I explained my problem said it was from "the devil." I also hated to disappoint my aging mother who was quite proud of her religious son. I took the easy way & continued in the Society. Living a life I do not believe has not made me proud of myself. I am afraid if I remain in the Society any longer I will become a bitter man.

MAR-PLMN 000049

The habits of a life time will make
me live as a good Christian. If it is God's
Will He might restore the faith I once
had.

At my age, it does not seem practical or
logical to leave the security of the Society. But,
I feel I have to live with myself. I don't
want to be bitter considering what could have
been.

Sincerely,

Bernard T. Pleimann

85 YAMATE-CHO, NAKA-KU,
YOKOHAMA, JAPAN
TEL. (045) 641-0065/6
〒 231

St. Joseph College

セント・ジョセフ・カレッジ

横浜市中区山手町85番地
電話 (045) 641-0065/6
郵便番号 231

Your Holiness Pope Paul VI

April 2, 1973

I, Bernard T. Pleimann, have been a member of the Society of Mary (Marianists) since my first vows on August 1935. I took my final vows in June 1940. Presently, I am 55 years of age.

I am asking for dispensation of my vows of poverty, celibacy & obedience. My problem is one of faith. More than 20 years ago I realized I did not truly believe in all of the Church's teaching. I had lost faith in all religions. The provincial to whom I explained my problem said it was from "the devil." I also hated to disappoint my aging mother who was quite proud of her religious son. I took the easy way - continued in the Society. Living a life I do not believe has not made me proud of myself. I am afraid if I remain in the Society any longer I will become a bitter man.

The habits of a life time will make me live as a good Christian. If it is God's Will He might restore the faith I once had.

At my age, it does not seem practical or logical to leave the security of the Society. But, I feel I have to live with myself. I don't want to bitter considering what could have been.

Sincerely,

Bernard T. Plimann

Steve Glodek

From: bbolts@juno.com
Sent: Tuesday, July 05, 2005 2:23 PM
To: Steve Glodek
Subject: Pending investigations

Hello Steve,

Hope your summer is going well. Today I received a phone call from the lawyer, Jim Burns, who is following up on alleged cases from Junipero Serra HS, Gardena. You referred him to me.

Just a quick summary on my part: I find it difficult to believe that either Jim McGloin or Barney Pleimann were guilty of inappropriate action with young men.

~~_____~~ who, I believe, is making the accusations was a little "different." At his introduction to me at the reunion of his class in 1984, he openly told me he was gay. (What do you do for an encore?) He may very well have not like either one, since I doubt if math (BP) and science (JMcG) were among his better subjects (conjecture on my part). He definitely did not tell me in the presence of another member of the class that he was "molested" by a Brother. He claims that another student was abused by BP. Knowing the student and since He has not made the accusation, I question it. I taught all three students. I hope that this gives you directly this summary.

You continue to be in my prayers, especially in dealing with these accusations.

Fraternally,

Bill

Get Juno Platinum for as low as \$6.95/month!
Unlimited Internet Access with 250MB of Email Storage.
Visit <http://www.juno.com/bestoffer> to sign up today!

June 19, 1973

Dear Fr. Bert,

I hope you got my aërogramme I sent.

The document arrived. There is a slow down strike in the Japanese P.O. so it took a while to get to me.

It is enclosed.

I'm mailing this from the station (airport).

I had hoped the document would arrive after my visit which could have possibly made me see a little differently

Sincerely
Bernard Heimann

00054

So sleepy I sealed this without the card

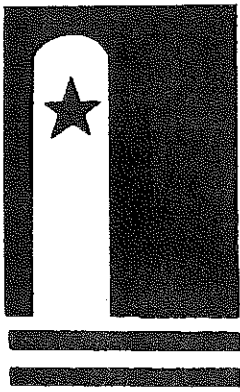

MARIANIST PROVINCIAL RESIDENCE

April 11, 1973

Very Rev. Stephen Tutas, S.M.
Marianisti
Via Latina 22
00179 Rome, ITALY

Dear Father Tutas:

I am enclosing with this letter the correspondence of Brother Bernard Pleimann addressed to Pope Paul VI in which Brother Pleimann asks for a dispensation from his perpetual vows of poverty, chastity, obedience and stability.

As Brother Pleimann indicates in his letter to His Holiness, Pope Paul VI, he was professed in the Society of Mary in 1935. Because Brother Pleimann is already in his middle fifties, we have endeavored to dissuade him from seeking a dispensation. Several years ago, Brother Pleimann wanted to ask for a dispensation, and I at that time dissuaded him. On this occasion when he first wrote to me telling me about his intention to seek a dispensation, I asked Brother Roger Richter, the Assistant Provincial, who was going to visit Japan to talk to Brother Pleimann about this. Brother Pleimann does not want to be dissuaded from seeking a dispensation at this time.

I have consulted with members of the Provincial Council, and we agree that we should send to you this letter of Brother Pleimann asking for a dispensation.

Brother Richter, the Assistant Provincial, upon his visit to Yokohama learned from the members of the religious community in which Brother Pleimann is presently living, that Brother Pleimann is drinking liquor quite heavily and is frequently intoxicated. He has been visiting saloons and has been seeing in the presence of women, which has been disconcerting for the religious community. I do not believe, from what I know of

000055

Very Rev. Stephen Tutas, S.M.

Page 2

April 11, 1973

Brother Pleimann, that he has a strong enough faith to sustain religious life. Because Brother Pleimann does not wish to be dissuaded from seeking a dispensation and because of the evident scandal that he can now already be giving, we urge that a dispensation be sought for Brother Pleimann. I know that this is not the first time that Brother Pleimann has had the desire to leave religious life.

Thank you very much for your consideration of this request. Be assured of our prayers.

Sincerely yours in J. M. J. .

Bertrand E. Clemens, S.M.

Very Rev. Bertrand E. Clemens, S.M.
Provincial Superior

Enclosure

000056

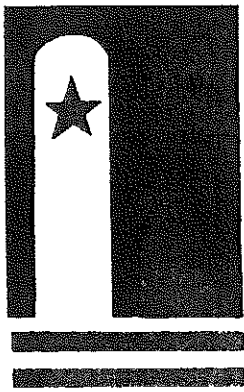

MARIANIST PROVINCIAL RESIDENCE

April 11, 1973

Reverend Vincent Vasey, S.M.
Marianisti
Via Latina 22
00179 Rome, ITALY

Dear Father Vasey,

I am sending to you the original copy of my letter to Father Tutas and the original copy of the letter of Brother Bernard Pleimann in which he requests a dispensation from his perpetual vows. I am doing this, so that you can act upon this immediately, if that is your agreement with the General Administration.

I am sending carbon copies of all this material to Father Tutas, and I am sending it directly to the General Administration and not to Africa.

At the present I do not know of any other religious in the Province with perpetual vows who are thinking of asking for a dispensation. This is good news, and I hope that I am not too optimistic, for the end of the school year has not yet come nor have we gone through the summer. However at present it seems that only a couple of temporary professed will be asking not to renew their vows this summer. It looks, therefore, as though our perseverance rate this year will be good. I hope this is so and such is our prayer.

Presently we have already approved four for the novitiate for next year. There is a possibility of one or the other besides these four. This is also good for us.

000056

Reverend Vincent Vasey, S.M.

Page 2

April 11, 1973

Thanks for all you are doing for us. You are in our prayers.

Sincerely yours in J. M. J. ,

Bertrand Clemens, S.M.

Very Rev. Bertrand E. Clemens, S.M.

Enclosures

P. S. I am wondering if the Sacred Congrégation is still working on the laicization of Father Peter Choo. You will remember that we submitted a request for a laicization of Pete Choo without his knowledge of this. I am wondering what might be the status in his case at this time. Thanks for any information you can give us in this regard.

Bert Clemens, S.M.

000058

85 YAMATE-CHO, NAKA-KU,
YOKOHAMA, JAPAN
TEL. (045) 641-0065/6
〒 231

St. Joseph College

セント・ジョセフ・カレッジ

横浜市中区山手町85番地
電話 (045) 641-0065/6
郵便番号 231

April 2, 1973

Your Holiness Pope Paul VI

I, Bernard T. Pleimann, have been a member of the Society of Mary (Maristists) since my first Novices in August 1935. I took my final vows in June 1940. Presently, I am 55 years of age.

I am asking for dispensation of my vows of poverty, celibacy & obedience. My problem is one of faith. More than 20 years ago I realized I did not truly believe in all of the Church's teaching. I had lost faith in all religions. The provincial to whom I explained my problem said it was from "the devil." I also hated to disappoint my aging mother who was quite proud of her religious son. I took the easy way & continued in the Society. Living a life I do not believe has not made me proud of myself. I am afraid if I remain in the Society any longer I will become ~~be~~ a bitter man.

000059

The habits of a life time will make me live as a good Christian. If it is God's Will He might restore the faith I once had.

at my age, it does not seem practical or logical to leave the security of the Society. But, I feel I have to live with myself. I don't want to be bitter considering what could have been.

Sincerely,

Bernard T. Heimann

000060

C O P Y

May 30, 1973

Brother Bernard Pleimann, S. M.
St. Joseph College
Nakaku, Yamate 85
Yokohama, JAPAN

Dear Barney,

The document containing your dispensation from your perpetual vows arrived and I am enclosing it with this letter.

As soon as you have received this document, you have ten days to decide if you want to accept the dispensation. When you receive this document, if you are still definitely determined to leave the Society of Mary, I would advise that you sign the enclosed return postcard to me immediately. As soon as you sign this postcard, your vows are dispensed.

If you are not clearly determined to leave the Society when you receive this document, I would advise that you endeavor as soon as possible to arrive at a decision through prayer and consultation. You have ten days in which to do this. If after ten days, you have not signed the enclosed postcard, your vows remain in effect and you are a Marianist in good standing. Later on then, if you would ever again decide to leave the Society of Mary, you would need begin again to request a dispensation. As I mentioned above, if you are still definitely determined to leave the Society when this document arrives, then sign the postcard immediately and your vows are no longer in existence. We would appreciate you returning the card in this case to us at once.

I hope all is going well with you, and that the school year is coming to a successful completion for you. I understand from Brother Roger that you might be teaching at St. Joseph's next year as a layman if you accept

000061

C O P Y

Brother Bernard Pleimann, S. M.

Page 2

May 30, 1973

your dispensation. Please do drop me a note and let me know your plans, for I am most interested in you and in your plans. I hope that everything has been thought through very carefully in regard to yourself and your plans.

If I can be of any further help to you, do let me know. You are in my prayers. God bless you!

Sincerely yours in J. M. J. ,

Very Rev. Bertrand E. Clemens, S. M.

Enclosures

000062

I have received the document from Rome.

6/6/73

(date received)

6/14/73

(date accepted)

Bernard A. Deimann

(signature)

000063



SACRA CONGREGATIO
PRO RELIGIOSIS
ET INSTITUTIS SAECULARIBUS

N. 17539/73

BEATISSIME PATER,

Frater Bernardus PLEIMANN,

professus a votis simplicibus perpetuis in Societate Mariae (Marianista-
rum),

cum ad onera vitae religiosae sustinenda se imparem sentiat, a Sanctitate Tua humil-
lime implorat indultum saecularizationis, ut in saeculum libere et legitime redire
valeat, ob rationes allatas.

Et Deus, etc.

Vigore facultatum a Summo Pontifice concessarum, Sacra Congregatio pro
Religiosis et Institutis saecularibus annuit pro gratia, iuxta preces, ita ut Orator,
deposita exteriori forma habitus religiosi, solutus a votis ceterisque obligationibus
suae Professionis, a sua Religione separatus maneat.

Praesens rescriptum nullius roboris esto si ab Oratore non fuerit acceptatum
infra decem dies ab eiusdem recepta communicatione.

Contrariis quibuslibet non obstantibus.

Datum Romae, die 15 maii 1973.

000064

Basilius Meiser, Op. Cas.
Subsecretarius

L. Addinola P.O.

C O P Y

April 11, 1973

Brother Bernard Pleimann, S.M.
St. Joseph College
Nakaku, Yamate 85
Yokohama, JAPAN

Dear Barney,

I have received your letter in which you requested a dispensation from your perpetual vows. I have forwarded your letter to the General Administration, and asked that they petition Rome that you be dispensed from your perpetual vows. As soon as I receive any information from Rome, I will contact you.

Certainly I am sorry that you are asking for this dispensation. However, Brother Roger mentioned that you did not want to be dissuaded from seeking the dispensation, so we have proceeded with requesting your dispensation from the Sacred Congregation.

I do hope that all will go well with you during the remainder of this year, and that you will begin to make plans for your future life, so that when the dispensation arrives, you will be able to adjust easily to the lay life. Be assured you are in our prayers. May your Easter be a blessed and joyous one.

Sincerely yours in J. M. J.,

Very Rev. Bertrand E. Clemens, S.M.

000065

May 22, 1971

Reverend Joseph Priestley, S. M.
The Marianists
5000 Mitty Way
San Jose, CA 95129

Dear Joe,

We are very grateful to you, Joe, for graciously accepting the summer assignment in Yosemite. You have always done an excellent job at Yosemite, and I know Father Thornton is delighted to have you help him again. Thanks for all this service and generosity.

I know that finances are a real consideration for you, so we want to do all that is possible to help you during this summer. It is been decided that you will receive \$150 a month for each of the three months you are serving in Yosemite. You will be, as agreed upon, serving Yosemite during June, July, and August. For each of these three months you will receive \$150, which is a total of \$450.

I will ask Brother Charles to first of all put whatever of this money is needed toward your car towards that payment. The rest then should be credited to your account. I am sure you will be able to check with Brother Charles and see that this handled with your understanding.

If there is any difficulty concerning this arrangement, do not hesitate to get in touch with me. I hope your summer will be a very enjoyable and profitable one. Keep up your good work, Joe. You are in our prayers and gratitude.

Sincerely yours in J. M. J. ,

Reverend Bertrand E. Clemens, S. M.

000066

August 22, 1970

C
O
P
Y

Brother Bernard Pleimann, S.M.
St. Joseph College
Nakaku, Yamate 85
Yokohama, Japan

Dear Bernie,

Thank you for your letter from Honolulu which you wrote while you were getting your visa and your physical examination. I hope that the doctor found nothing seriously wrong with you when you took the tests and had your examination. Do write to me and let me know what the doctor's report was. I am quite interested and also concerned.

Besides thanking you for your letter from Honolulu, I want to take this occasion to welcome you to the community in Yokohama. I am sure you will do much good for that community and also for the high school there. I am sure you will like it in the community at Yokohama. There is a good spirit in the community. I hear, that the beer in Japan is quite good.

Thanks, Bernie, for all the wonderful work you did at Santa Cruz this summer. You certainly helped to keep that place in good shape, while workers were very few there. Thanks again for everything, Bernie, and do have a wonderful year. You are in our prayers keep us in yours.

Sincerely yours in J. M. J. .

Father Bertrand E. Clemens, S.M.

000067

July 28, 1970

Brother Bernard Pleimann, S.M.
The Marianists
175 Phelan Avenue
San Francisco, California 94112

Dear Bernie,

I have your note concerning your visa and traveling plans to Yokohama. When you apply for your visa at the Japanese Consulate tell them that you are a missionary. If they want further explanation tell them that you are a Roman Catholic religious who will be doing teaching in Yokohama.

You will be obliged to take copies of a letter which I am preparing, and to give these to the Japanese Consulate. I cannot enclose these letters at the moment, because they must be notarized, and I will await until Brother Frank Lahey arrives back at the Provincial Residence. Brother Frank should be back in a day or so. As soon as they are notarized by him I will send them to you at Riordan.

~~Each is bringing~~ to ask Brother Masur to send you letters, just in case you need letters from someone in Yokohama.

Brother Frank Lahey takes care of all traveling arrangements. I shall give him your letter and ask him to see what he can do with regard to making arrangements for you. I will tell him that if he has any difficulty to get in touch with you at Riordan.

If you have any further difficulties do not hesitate to get in contact with me. You should receive copies of my letter to the Consulate in a few days. I do hope you have a most delightful trip to Yokohama, and that your stay in Yokohama will be most enjoyable and profitable. We are most grateful.

000070

000069

C
O
P
Y

Brother Bernard Pleimann, S.M.

July 28, 1970

Page 2

to you for volunteering for Yokohama. Many thanks for all you are doing, Bernie. We also appreciate more than we can say the work that you did at Santa Cruz this summer. God bless you.

Sincerely yours in J.M.J.,

Father Bertrand E. Clemens, S.M.

C
O
P
Y

000071

THE MARIANISTS
3140 WAIALAE AVENUE
HONOLULU, HAWAII 96816

ANSWERED

JUN 12 AM '69

CHAMINADE COLLEGE
OF HONOLULU

SAINT LOUIS
HIGH SCHOOL

June 5, 1969

Rev. Bert Clemens
P.O. Box 937
Cupertino, Cal. 95014

Dear Father Bert,

I hope this finds you in the best of health.

Retreat ends tomorrow. I also leave on the trip tomorrow.

There is little change in the way I feel.

If I should decide to stay the change I'll need is one of work (not necessarily local). If it teaching perhaps college at Chaminda or intermedia at Canoga Park.

000072

If you wish to contact me, I'll be a day in Yokohama July 20th and will probably stop in on the "Bluff." The boat leaves Manila on July 13

I probably could receive mail
if addressed to
Passenger Service
SS President Cleveland
American President Lines
Manila, Philippines

Aloha,

Bernard F. Herman

000073

June 12, 1969

Brother Bernard Pleimans S.M.
c/o St. Joseph College
Nakaku, Yamate 85
Yokohama, Japan

Dear Brother Bernard,

Your letter of June 5, 1969, arrived here in Cupertino while Father Clemens was still ill. Therefore, I am answering in his name.

Father Clemens explained to me your feelings concerning staying in the Society of Mary. We felt that a change of schools would do you a great deal of good. Father explained to me that you particularly thought a great deal of Father John McEnhill. Therefore, you are assigned next year to Riordan High School in San Francisco. Since this assignment was made some time ago, and they are counting on your being there, I think it would be better at this time, Barney, if we followed through on that plan. The following year we certainly could talk about the possibilities of either teaching at Chaminade College or at the intermediate level at Chaminade Prep in Canoga Park.

I hope that you will stay with us in the province since we depend so heavily on you as one of our most competent and professional educators. Likewise, I feel it would be a rather tragic mistake for you to leave the Society of Mary at this time. If there is anything that I can do, please do let me know. So, Barney, in summary then, we ask that you teach next year at Riordan High School in San Francisco.

I hope that your trip is going well and that you are enjoying your experiences on the high seas. Have you caught much in the line of fish?

000074

Sincerely yours in J.M.J.,

Brother Roger D. Richter, S.M.

C
O
P
Y

28 March 1969

Brother Bernard Pleimann, S. M.
The Marianists
3140 Waiialae Avenue
Honolulu, Hawaii - 96816

C Dear Bernie:

O Many thanks for your letter of 24 March. I appreciate very much your writing, and for clarifying a misunderstanding that I may have had. I do sincerely hope, however, that you have changed your mind or will change your mind. You are very much in my thoughts and prayers these days and I pray that our Risen Lord at this Easter Season will give you the faith you need to see clearly to persevere in your religious vocation.

P I am sure that you have a religious vocation, and that you should persevere in it. I can understand that, for one reason or another, one's faith or one's convictions can have been dimmed. This cannot always be recovered and developed through prayer and the sacraments. But, receive the sacraments frequently, worthily, and devoutly. Our Lord can only help you so that you might see with the clarity that the apostles saw after the resurrection of Christ.

Y If you do get a chance, do continue to write to me. You are very much in my prayers. I do want to see you remain in the Society of Mary. May your Easter be a blessed and joyous one. God love you!

Sincerely yours in J. M. J.,

Father Bertrand E. Clemens, S. M.

000075

MAR 28 ANSD

THE MARIANISTS

3140 WAIALAE AVENUE
HONOLULU, HAWAII 96816

CHAMINADE COLLEGE
OF HONOLULU

SAINT LOUIS
HIGH SCHOOL

March 24

V. Rev. Bertrand E. Clemens S.M.

Dear Father Clemens,

I received your letter a few days ago.

One part was in error or you misunderstood me. At the time of discussion you mentioned as I was leaving that you wanted to destroy the letter. I answered, "I don't care but I don't think I will change my mind." So in the second conversation there was no change in my feeling.

Time is flying now. Looking forward to Easter vacation. Wishing you a Happy Easter.

000076

Sincerely
B. Plimann

March 14, 1969

Brother Bernard Fleimann, S.M.
St. Louis High School
3140 Waialae Avenue
Honolulu, Hawaii 96816

Dear Barney,

I thought I would write to you, in order that I might follow-up some thoughts about your religious vocation.

Naturally, I was quite surprised and disappointed when you first told me that you were thinking of asking for a dispensation. As I mentioned to you on that occasion, I am certain that this is a wrong decision for you to make. I am still very certain about this opinion.

I do realize you have had disappointments, and difficulties with some of the administrations. I was surprised and felt very sorry that I had misunderstood you in past when you asked for a change of community from St. Louis. I sincerely believe that you were willing to stay here, because at that time Joe Hoffman really wanted you to remain. Now I understand from you, that you in reality did not interiorally did not accept this decision. I certainly was mistaken.

You tell me that you want to leave primarily because you have no faith. If this is correct then you have no faith, then the solution is that we do everything possible to revive your faith. It is imperative that you have faith. I will do everything possible in order to help you to get back your faith. Certainly it will need your effort as well as our help.

000077

C
O
P
Y

Brother Bernard Pleimann, S.M.
14 March 1969

2

C
O
P
Y

After our first conversation together, you had agreed that I would destroy the letter that you had written asking for a dispensation. During our second conversation you seemed to indicate that you had again thought of leaving. I would seriously urge you not to plan to leave. You should remain a Marianist and do everything possible to get back your faith and your religious spirit. In order to start this I believe that it is necessary to have a change of communities. Riordan and teaching under Father John McEnhill will be most helpful to you, I am sure. Then you should make a good annual retreat this summer and a good confession. This is a start and an important one. I am sure that if you really devote yourself seriously and honestly to your religious duties this will be a great help in reviving your faith. There are other things to that will help, and I will see that you and I can work these out together.

I would seriously urge you that you do not plan to leave the Society. This would be a very great mistake for you. I will help you in any way I can, and when you are at Riordan I will be able to contact you frequently there.

If you get a little time, do write to me and perhaps even in correspondence we can begin to work together for fulfilling your needs. I am most interested in you personally, and I have always felt a closeness to you because of your association with me in our Novitiate group. I always admired and envied you mathematical ability. I do remember the many times we use to spend together at the blackboard in working out algebra for Brother Holtzmer. I always admired your thinking.

Do find a little time to write, and I will keep in correspondence with you. You are daily in my prayers please keep me in yours.

Sincerely yours in J.M.J.,

Bather Bertrand E. Clemens, S.M.

000078

29 March 1968

Brother Bernard Pleimann, S.M.
The Marianists
3140 Waialae Avenue
Honolulu, Hawaii - 96816

Dear Bernie:

I have your information sheet here on your visit home for this summer. I have noted also that you will be the recipient of a grant in Norman, Oklahoma. I have passed this information on to Brother Roger Richter.

Since your trip to Oklahoma will be financed by your grant, but the rest of your trip to Cincinnati and Cincinnati back to Honolulu will be a province expense, I think that it would be good for you to write to Brother Frank Lahey and to explain to him how you wish your tickets to be made out. It may be that you will need to distinct tickets. Also, you may want to have Brother Frank to send you open tickets so that it will make it convenient for you to fill them in once you have definite dates.

I just did not want to have you left stranded concerning tickets, so I am writing to you about them at this time. I am sure that Brother Frank Lahey will be happy to take care of the tickets for you when you write to him. I do think that you would do well to have Brother Frank send you open tickets. If there is any other arrangement that is more convenient than the one that I suggested, do not hesitate to ask Brother Lahey to make them for you.

Thanks for all the wonderful work that you are doing in Honolulu, Bernie. I am very happy that you have received the grant to study in Oklahoma this summer. I am sure that you will profit much from the studies and enjoy the trip to this state. Keep us in your prayers as you are in ours.

Sincerely yours in J. M. J.,

Sim
Father Bertrand E. Clemens, S.M.

cc: Brother Frank Lahey, S.M.

000079

C
O
P
Y

4 August 1965

Brother Bernard Pleimann, S. M.
P. O. Box 7228
Stanford University
Stanford, California

Dear Bernie:

Thank you for your letter of 1 August. I am happy to hear that your summer has been most profitable. You certainly have our permission to go to Los Angeles and to stay for a little rest there.

I would advise, that you go to Canoga Park because Serza will be loaded. Just write Hogie at Canoga Park and tell him that you are coming.

You have our permission to stay in the Southland from three to five days. If you think that a longer time is necessary just let me know.

Let Brother Steele know when you will be arriving back in Honolulu. You may purchase your ticket to the Islands for which you have money as you stated in your letter.

Thanks, again, for writing, Bernie, and have a nice time in Los Angeles.

Keep us in your prayers as you are in ours.

Sincerely yours in J. M. J.,

Father Bertrand E. Clemens, S. M.

000080

C
O
P
Y

P.O. Box 7228
STANFORD UNIV.
STANFORD, CAL.
8/1/65

Very Res. Fr. Bertrand Clemens

ACC 4 = ANSD

Dear Father Provincial,

Two more weeks are left of this summer grant. I feel I have profited very much by it. The lecturers have brought us up-to-date both in science & in mathematics. The special field trips were most enlightening. I feel it will help me to better prepare my papers for a science or math field.

The end comes after the last exams on Saturday 14th. A banquet is planned for the entire group that evening.

I would like to request permission for a short stay or rest or vacation (whatever it can be called) in the L.A. area with a chance to visit my nephew in Riverside. I would prefer Serra but I realize it will be "loaded" with retreatants. Perhaps, I could stay at Chaminade. When I left Hawaii I had a ONE WAY ticket just in case. I'll have 000081 sufficient cash to purchase a return ticket if you want me to. Since Shell gave me an allotment to cover at least one way, if I may be permitted to go south I can get a ride with one of

the fellows in this group who
will be enroute to Texas.

I'm sending this to San Jose
as I have forgotten the Santa
Cruz box number.

Sincerely,

Bis Bernard Fleissner

000082

24 May 1961

Brother Bernard Fleiseman, S.M.
The Marielists
3140 Waialae Avenue
Honolulu 16, Hawaii

Dear Bernie:

Thank you very much for your letter of 14 May in which you gave me your address at Stanford for the summer. I am sure that you will profit very much by this Shell grant.

You will notice that you were placed at Mitty High School on the summer personnel. I do not know what the requirements are for this grant, nor do I know what will be required of you while you are in session during the week. However, if the weekends are free, it would be appreciated if you could stay at Mitty. I am sure that you would want to be in community for the weekend if that is possible. If it is not possible, then do not be concerned about it.

You might write to Brother Allen DeLong and let him know whether or not you will want a room over the weekends so that he will be able to plan a little more definitely concerning his house for the summer.

Have a real nice summer, Bernie, and I am looking forward to seeing you if you are around this neck of the woods.

Keep up your excellent work that you are doing for the students at St. Louis High School. It is deeply appreciated. We want to do all we can to make this an outstanding high school. You are helping.

Keep us in your prayers.

Sincerely yours in J. M. J.,

000083

Father Bertrand E. Clemens, S.M.

MAY 24 AM '65



ST. LOUIS HIGH SCHOOL
conducted by the marianists

3140 WAIALAE AVE. TELEPHONE 741-904
HONOLULU, HAWAII 96816

May 16, 1965

Very Rev. Fr. Bertrand Clemens S.M.
Dear Father Provincial,

As requested by your Provincial Memorandum No. 7 I am sending you the address of the 'Shell Merit Fellows' for the summer of 1965. All the 'Fellows' are expected to be housed in Wilbur Hall on the Stanford Campus. As yet I do not know the telephone number. I will be able to give it to you when I find out.

Summer School will be of eight weeks. It starts on the 21st of June. There will be a get-together on the afternoon of the 20th.

I am looking forward to a very profitable summer.

Sincerely yours in J.M.J.

A handwritten signature in cursive script that reads "Bro. Bernard T. Pleimann S.M." The signature is written in dark ink and is positioned above the typed name.

Bro. Bernard T. Pleimann S.M.

000084

gone from
repeated. Tell
to stay at Canoga
OK
announced Aug 6

SUPO Box 10433
Univ. of Arizona
Tucson, Arizona

Very Rev. & Bent Clemens
Dear Father Provincial,

Six weeks are over -
two more to go! I find
myself 12 pounds lighter - &
not so much smarter. I've
sure found out how much
I can forget.

The last day of classes
is the 14th of August. I should
be able to catch a train on 15th
if I can clean up some incidentals
I would like to stop over at
Riverside, Cal. to visit my
nephew Mr. Richard Plimann.
After that he could drive
me to airport, Gardena ⁰⁰⁰⁰⁸⁵
Canoga Park. I would like
to have a few days in L.A.
area before returning to Hawaii.

I realize that Sevier will probably be crowded with retreatants. I was hoping to am asking permission to spend a few days in Garden or Canoga Park.

Thanking you,

Sincerely,
Bro. Leonard Thomas

000086

29 June 1964

Brother Bernard Pleiniann, S. M.
SUPO Box 10433
University of Arizona
Tucson, Arizona

Dear Barnie:

Many thanks for your interesting letter of 23 June.

I appreciate your writing and also your sending the timetable to me.

I am glad that you are enjoying your courses and I am sure they are keeping you very busy. I hope you will find the courses not only stimulating but a real change for you from the routine of the school year.

Have a very enjoyable vacation, Barnie, and we will be thinking of you in our prayers. Continue to remember us in your prayers.

Sincerely yours in J. M. J.,

Father Bertrand E. Clemens, S. M.

000087

SUPD BUL 10433
U. of Arizona
Tucson Arizona
June 23, 1964

JUN 29 ANSD

V. Rev. Father Bert Clemens
Dear Father Provincial,

I arrived safely.

School has been going full
blast since the start on Monday.
They certainly know how to get
you to work. Special meetings,
seminars, conferences, problem
sessions ... all in addition to
the regular scheduled courses.
I've signed up for two:
Probability & Statistics & Math
Analysis. Beginning tomorrow
they decided it would be nice
if we learned more about
computers. So twice a week
we will go to the computer
center & once a week a

000033

week a lecture on Programming...
This knocks out the three ^{morning} hours I
had open in a week. My
schedule which varies with
the time of the seminars. I've
been rising around 5:30 - 6:00
make my meditation & walking
to church (usually it takes about
35 minutes, Mass, (6:30) walk
(office) [ride a bus when there's
an early meeting] breakfast
Classes are study starts at 8
These run to 2 & twice a
week to 3. I make a visit to
Newman Club Chapel & say the
rosary before the evening meal.
I've been retiring around 10

Bro B. Flinn

14 August 1963

Brother Bernard Fleimann, S. M.
SUPO
Box 10334
University of Arizona
Tucson 20, Arizona

Dear Barnie:

Many thanks for your letter of 11 August. I deeply appreciate your congratulations and prayers on the occasion of my Silver Sacerdotal Jubilee.

I was interested in your evaluation of the summer session that you have had and I am pleased that you found it challenging.

I am happy that you will be able to have the visit with your folks and I know how much happiness and joy it will bring to your mother.

Barnie, since you will be arriving in Honolulu so late, I think it would be courteous to drop Brother Hoffman a letter indicating when you will be arriving. Their classes will open on 3 September.

The second province retreat being preached by Father Frank Kenney is in session at Riordan High. The first one went off very smoothly and on the 11 we had the installation of Brother Hugh Hoganson as the new superior at Canoga Park.

Please keep us all in your prayers and God's blessing on your final days of this summer session.

Devotedly yours in J. M. J.,

000090

Father Leonard M. Fee, S.M.

SOPD Box 10334
Univ. of Arizona
Tucson, 20, Ariz.
Aug. 11, 1963

Very Rev. Leonard Jee S. Fr.

AUG 13 ANS'D

Dear Father Jee,

Aloha!

Best wishes & congratulations
on your Silver Anniversary of
Priesthood.

The eight weeks of Summer
School ~~is~~ is fast drawing to an
end. We were kept very busy. I'd
say the busiest I've ever experienced.
The teachers have been good, especially
one, Dr. Hess, who is probably one
of the best I've ever had.

On August 23rd I am
leaving for Cincinnati. I will be
staying with my sister & mother
at my sister's home in Bethel,
Ohio. The address is,

000091

Crane School House Rd
RR 2 Box 197
Bethel, Ohio 45106

I am looking forward to this
visit & I'm sure my mother is,
too.

Best wishes

Faternally in Christ.

Bro. Bernard Thuman

000032

SUPO Box 10334
Univ. of Arizona
Tucson, 20, Arizona
June 28, 1963

V. Rev. Father Fee,
Dear Father,

A couple of days of school are over & am beginning to get into the swing of things.

Weather is hot... over 100 yesterday - cooler today - just under 100. Room is much cooler. Classrooms are sometimes chilly esp. when you come in from outside.

I get up around 5:45 say morning prayers & office walking to church, SS Peter & Paul, the Cathedral or at Newman Club. Newman Club is just off campus but if the priest has

000093

parish duties there is no
6:45 Mass. The churches have
it at 6:30 - they are a
pleasant walk (beautiful
^{20-25 minute}
mornings). I catch a bus
^{7:20}
to the U., breakfast, catch
up on news.

Classes run from 8:30 to
noon - 2 courses, seminar.
Some afternoons from 1-3
with problems sessions,
meeting or special lectures
by visiting mathematicians,
scientists, etc. A seminar &
a rest complete the afternoon.
After evening meal I'll ~~make~~ ^{make}
a visit at the Women's Club,
recrey etc or go to
evening services at the
Cathedral.

000094

Alaka,

Bros Bernard Flynn

Pleimann, Bernard Thomas

GENERAL INFORMATION

NAME: Family Name *Pleimann*
 Christian Name *Bernard*
 ADDRESS: Father's Name *Charles*
 Mother's Name *Mary Sauer*
 Father *2208 Hanford Ave. Norwood, O*
 Mother
 Guardian
 BIRTH PLACE: City *Norwood*
 State *Ohio*
 DATE OF BIRTH: *April 10, 1917*
 POSTULATE: Entered at *Mt. St. John*
 NOVITIATE: Date of entrance *Aug 1, 1932*
 Entered at *Mt. St. John*
 Date of entrance *Aug 17, 1934*
 Date of leaving *Aug 16, 1935*

TEMPORARY VOWS

Place	Date	Term
<i>Mt. St. John</i>	<i>Aug 15, 1935</i>	<i>one year</i>
<i>"</i>	<i>July 11, 1934</i>	<i>"</i>
<i>Santa Cruz, Cal.</i>	<i>July 10, 1937</i>	<i>"</i>
<i>Honolulu, T.H.C.</i>	<i>July 31, 1938</i>	<i>"</i>
<i>"</i>	<i>July 16, 1939</i>	<i>"</i>

PERPETUAL VOWS

Place *Honolulu, T.H.C. - S.L.C.* Date *July 7, 1940*

000095

PLACES AND EMPLOYMENT

Date	Place	Employment	Director
Aug. 14, 1935	MA St. John	Scholastic	Rev. John Rauscher
Aug. 10, 1938	S. Francisco St. James	Teacher	Bro. Peter Maier
Aug. 9, 1937	Hilo, N.H.	"	Lawrence Cluntholt
Aug. 27, 1939	Honolulu-S.L.C.	"	Bro. Paul Sibbing
Aug. 20, 1940	Hono. Cath. Sch.	"	Bro. John Melker
Aug. 19, 1941	Hono.-Cath. Sch.	Teacher	Bro. Charles Reiter
Aug. 19, 1942	Honolulu-S.L.C.	"	Bro. Paul Sibbing
Aug. 3, 1945	Brook.-St. J.H.	Prefect	Bro. Matt. Bätz
June 28, 1946	Honolulu-S.L.C.	Teacher	Bro. Leo Rausch
Aug. 15, 1947	Hilo, T.H.	Teacher	Bro. Benedict Wengler
Aug. 21, 1948	Hilo	Teacher	Rev. Thomas Hogan
June 17, 1951	Dayton	Student	Fr. Rennecker
July, 1952	Gardena	Teacher	Rev. W. Swegar
..... 1953	Gardena	Teacher	Bro.acht, Rev. Donald
..... 1956	"	"	Bro. J. Hoffman

SCHOLARSHIP

- High School Diploma
- Teacher's Elementary Certificate
- Teacher's High School Certificate
- Degrees

REMARKS

000036

For Archives Department: July 10, 1962

Brother Pleiman: Please complete
attached records and return to my mail
box. THANK YOU!

Note: If you have a print of yourself
please place in folder.

— Brother Adrian Keohe

000097



J. M. J.

PROVINCE OF CINCINNATI

Personal Information Form

Name of Religious Bro. Bernard T. Fleimann

Father's Name (if living) Charles Fleimann

Place of Birth Ft. Thomas, Kentucky

Mother's Maiden Name (if living) Mary Lreke

Place of Birth Covington, Kentucky

*Addresses of nearest of kin and degree of relationship:

Name & Relationship Mrs. Chas. Fleimann (mother)

Address 2208 Hannaford Avenue

Norwood, Ohio

Name & Relationship _____

Address _____

Name & Relationship _____

Address _____

Name & Relationship _____

000038

Address _____

Name & Relationship _____

Address _____

*Please inform the Provincial at once of the change in address of the nearest of kin.

Vade Mecum for Traveling

* * * * *

Mount St. John, Dayton, Ohio

No. 648..

..... July 19....., 1946.

Brother . Bernard Pleimann..... is hereby authorized to go
from Brooklyn..... to Cincinnati.....
from to
for the purpose of ...visit home..... and to remain there
8 full days. Lodge in local community.....
According to instructions of Father Provincial.
Leave Return

* * * * *

NOTA BENE

1. "When a Religious goes to a place where the Society has an establishment, he may not lodge outside the community, not even with his parents or relatives" (Const., Art. 248). Religious are requested to notify Directors about their arrival several days in advance.
2. "Never should the lay religious consider himself a secular. If by his costume he differs less from the people of the world than the members of other Institutes, he is all the more bound to distinguish himself from seculars by a grave and modest exterior (Const., Art. 351).
3. "Mental and vocal prayers are performed preferably before the Blessed Sacrament" (Const., Art.128). It is suggested that the Religious take with him his Formulary and a copy of the Imitation of Christ.
4. "No present is solicited; none is accepted unless for the community or for the chapel. Every personal present is refused" (Const., Art. 40).
5. "The Religious ... denies himself familiarities and every unbecoming liberty ... especially does he avoid persons of the other sex" (Const., Art. 46). "In the vigilance which he exercises over his senses and in the privations which chastity imposes he finds a source of merit and consolations" (Const., Art. 47).
6. "Mortification directs and sanctifies the use of the senses by the holiness of the intention. There is for the professed nothing beautiful, nothing agreeable or curious to see or hear solely for the purpose of procuring for himself some gratification, after the manner of the world. Worldly amusements, futile conversations, frivolous correspondence, or

000099

reading, pleasure excursions, exist no longer for him; he shuns such disedifying crowds as vain curiosity attracts sometimes even to the church" (Const., Art.171).

7. "The Chapter decides that the Director, whilst giving the Religious his traveling money, shall also give him a written or printed note on which shall be indicated the sum given, and which the Religious shall give back at his return, properly filled out, with a detailed list of his expenses and the sum of money still remaining. This statute is applicable to all changes of residence involving expenses. The Vade Mecum is to be returned to the Provincial by the Director as soon as possible after the return of the Religious" (General Chapter of 1896, page 125. (General Chapter of 1939, pages 374 and 375).

8. It is recommended to continue the laudable custom of saying the Litany of the Blessed Virgin before each journey for the personal safety of the Religious.

Amount received upon departure	175	
Presents		
Itemized Expenses	175	
Railroad Fare ... <i>Bklyn to S.J.</i>	83	36
Meals	15	65
Car Fare ... <i>TAXI</i>	5	85
<i>TIPS</i>	5	25 ← 8.25
<i>Souvenirs, Cards & Stamps</i>	1	85
<i>Baggage (checking etc.)</i>	2	24
<i>Watches Repaired</i>	10	00
<i>Misc</i>	2	35
Total Expenses	129	75
Balance given to Director upon return	45	26
Total	175	

Aug. 26, 1946 ... *Leo S. Rausch S.M.*
 Date of return ... Director

Alvius J. Seitz
 Provincial

V. M. of *Bernard Pleimann*

J. M. J.

For the glory of the Most Holy Trinity,
the honor of Mary, and the salvation of my
soul, I Bernard Heimann
promise to God and vow to observe during
one year, Poverty, Chastity and Obedience,
conformably to the Constitutions of the So-
ciety of Mary.

Honolulu, St. Louis College
Mount St. John, July 16 1939

Bernard Heimann

Rev. Aloysius J. Bedel, S.M.

J. M. J.

For the glory of the Most Holy Trinity,
the honor of Mary, and the salvation of my
soul, I Bernard Heimann
promise to God and vow to observe during
my whole life, Poverty, Chastity, Obedience,
and Stability, conformably to the Constitu-
tions of the Society of Mary.

Honolulu, St. Louis College
Hawaii, July 7 1940

Bernard Heimann

J. M. J.

For the glory of the Most Holy Trinity,
the honor of Mary, and the salvation of
my soul, I Bernard Hermann
promise to God and vow to observe dur-
ing one year, Poverty, Chastity and
Obedience, conformably to the Constitu-
tions of the Society of Mary.

Sancta Cruz
Mount St. John, July 10 1937

Bernard Hermann

J. M. J.

For the glory of the Most Holy Trinity,
the honor of Mary, and the salvation of my
soul, I Bernard Hermann
promise to God and vow to observe during
one year, Poverty, Chastity, and Obedience,
conformably to the Constitutions of the So-
ciety of Mary.

St. Louis College
Nazareth, Dayton, O. July 31 1938
Honolulu Hawaii
Bro. Bernard Hermann

000102

June 9, 1940

Brother Bernard Fleimann,
St. Louis College,
Honolulu, T. H.

Dear Brother Bernard,

I am pleased to notify you that our Vicar-General, now our supreme authority, has given an affirmative answer to your application for perpetual vows. This is a cause of thanksgiving to God and our Blessed Mother. In this duty of gratitude I will join you.

Prepare well for the day of your total consecration of your life to God in the service of our Blessed Mother, by strict observance of our holy Rule, by the strict keeping of your religious vows, by the cultivation of the family spirit, and by fervent prayer.

Congratulations!

Very devotedly yours in J. M. J.,

000103

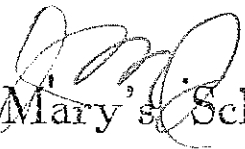

Saint Mary's School

507 Waiianuenu St.

Hilo, Hawaii.

May 21, 1939

Very Rev. Walter C. Fredtin S. M.

Dear Father:

I am writing you requesting the favor of renewing my Temporary Vows for another year. With the grace of God I will make this coming year the best year of my life if you will grant my request.

My health, thank God, could not be much better. I have little trouble in the classroom, thanks to my dear Mother Mary to whom I dedicate each endeavor whose guidance and care I place myself and my boys.

Begging you to allow me to renew my vows, I remain

Your obedient servant
in J. M. F.

000104

Brother Bernard Olinas

J. M. J.
MOUNT SAINT JOHN
R. 12 - BOX 71
DAYTON, O

May 21, 1935

Very Rev. Joseph Tetzlaff, Provincial
Rev. Father Provincial:

Since the time of my probation is almost up, I must beg of you to admit me to the first profession of the three vows of religion. I believe that this is the greatest grace God could bestow after that of Baptism. I know I do not of my own dispositions merit this great gift. I beg of you to forgive and forget my defects, both physical and spiritual, which, I hope, are the only obstacles standing between me and the profession of vows. I feel that God has called me to the Society of Mary

000105

and with His grace and your permission I hope to be permitted to take vows and then, the grace to persevere in my calling. I have chosen this Society to any other because it is consecrated in an especial manner to my dear Mother Mary and also because in it I believe I can work out my own salvation and salvation of others.

If I have the good fortune to be admitted, I also ask another favor, namely, of becoming a Teaching Brother, but I resign myself to your decision. I know that God in His Divine Providence did not give me "ten talents" but I, like the other servant, mentioned in the Gospel, will try to double what He has given me.

000106

MOUNT SAINT JOHN

R. 12 — BOX 71

DAYTON, O

My Confessor has given
me the permission to make vows.

As regards to going to
the Islands or to any mission
country I would gladly go at any
time, for in the eyes of Faith,
the Superior's will is God's will.

I remain

Your obedient Novice

Bernard Pleimann

0001.07

SOCIETY DE MARIE
PROVINCE DE CINCINNATI

Renseignements relatifs aux vœux perpétuels

St. Louis College,
Demandés par M. Bernard Pleimann de Honolulu, T. H.

Né le April 10th, 1917.....

Premiers vœux le August 15th, 1935.....

Demandes antérieures en en..... en.....

Voix de la communauté	{	Pour:.....45.....
		Contre:.....5.....
		Ne se prononcent pas:.....3.....

Principales observations pour: Steady, even, agreeable character; faithful to religious exercises and class work; regular in rising; successful in his work; has fairly good judgment; dealings with Superiors good; has family spirit; ready to help in the work of the community; employs time fairly well; good religious and devoted teacher. Seems to know what he is doing; not ostentatious. Has the spirit of charity; good character and seems to be satisfactory in his dealings with superiors, fellow-Brothers, pupils.

Principales observations contre: etc.

Childish at times; silence could be improved; one religious writes: "Gloomy, other lengthily melancholic; inclined to impudence in his dealings with fellow-Brothers; too self-centered too much reading novels." Slightly flighty; somewhat of a trifler. Rather drowsy during prayers. Another religious writes: "Inclined to be very headstrong which at times should not go un-

Voix du Conseil du Provincial	{	Pour:.....5.....
		Contre:.....0.....
		Ne se prononcent pas:.....

Principales observations pour: A steady, faithful religious; his general conduct shows the proper spirit; the defects quoted above will be overcome in time. He is sincere.

Principales observations contre:

Avis du Conseil du Provincial:

Observations, s'il y a lieu:

000108

MOUNT ST. JOHN, le 27 mars 1940.....

Le Provincial

noticed. I believe more effort could be made to stay awake during meditation. I believe that he has the necessary qualifications." Another writes: "Health seems good, but his hearing is rather poor for a young man. I think the doctor should be consulted on the seriousness of this defect. Should he soon become deaf, he would be a burden for years." Another: "Too easily provoked to anger, regardless of persons involved." Another: "Due to inexperience lacks religious seriousness. Make poor decisions. Needs firmer judgment." Another: "Needs more of an adult outlook on life. His first year at St. Louis is too much of a contrast to that of St. Mary's, Hilo. Favor one year delay to study tendencies towards cliques."

000109

J. M. J.

Destination des Sujets (Const., art. 335-336).

M. Pleiman, Bernard, Thomas
Né à Norwood, O. le 10 avril 1917.
Entré au Postulat de Mt. Jean le 1 août 1932.
Classement final sur postulants de (1)
Entré au Novicat de Mt. Jean le 14 août 1934.

Observations générales des bulletins du Novicat:
1er trimestre Ce novice est ordinaire. Il est
docile, mais n'est pas bien doué.
Il se conduit bien et est ass. studieux.
2e trimestre Il continue à bien se conduire.
Il a bon cœur, et quelquefois cela le trahit dans
ses manières. Il prend bien les remarques.
3e trimestre

Classement du dernier examen: 16 sur 24 novices.

Remarques spéciales concernant:

La famille, la première éducation, l'origine de la vocation;

La santé, l'intelligence, le caractère, l'esprit religieux;

Les aptitudes, les attrait du sujet

La famille est bonne, bien honnête.
Il a reçu sa première éducation des sœurs.
Il a fait deux ans de High School à Purcell.
Son caractère est positif. Intelligence bien
ordinaire. Santé bonne.

(1) Désigner la classe.

000110

Avis du Conseil du noviciat :

1. Touchant l'admission aux vœux *Le Conseil est :*
en faveur de ses vœux.

2. Touchant la destination du sujet *M. Desmet, devenu*
frère enseignant dans certaines paroisses.

Fait à *Mt. Jean*, le *25 mai* 1935

LE MAITRE DES NOVICES,

Geo Meyer

Avis du Conseil du Provincial :

1. Touchant l'admission aux vœux *L'admettre*
Il est peu bon mais très bien disposé
et travaillé.

2. Touchant la destination du sujet *frère enseignant.*

Fait à *Mt. Jean*, le *5 juin* 1935.

LE PROVINCIAL,

Jos A. Leszloff S.M.

Decision de l'Administration generale :

Touchant la destination du sujet *laïque enseignant.*

Fait à Nivelles, le *6 juillet* 1935.

Jung
Ch.

000111

J. M. J.

Novitiat de Mt. St. John

Bulletin du 1^{er} (1) July 1935

M. (2) Pleimon au Bernard né le April 10 1917

à Novato, D. dép^s d

Entré au postulat le Aug. 14 1932

A commencé son noviciat le Dec. 14 1934

Notes generales

Constitution	<u>fair</u>	Application à l'étude	<u>good</u>
Taille	<u>1 m. 77</u>	Esprit de foi	<u>seems good</u>
Santé	<u>good</u>	Id. d'obéissance	<u>good</u>
Extérieur, tenue	<u>ordinary</u>	Id. de pauvreté	<u>"</u>
Politesse	<u>good</u>	Id. d'abnégation	<u>"</u>
Jugement	<u>correct</u>	Id. de charité	<u>has some</u>
Caractère	<u>decided</u>	Id. de famille	<u>"</u>
Attach. à la vocation	<u>seems good</u>	Docilité à la correction	<u>yes</u>
Ouverture	<u>frank</u>	Facultés saillantes	<u>ordinary</u>
Piété	<u>good</u>	Aptitudes particulières	<u>"</u>
Régularité	<u>"</u>	Défauts saillants	<u>nothing particular</u>
Silence	<u>"</u>		

Enseignement	Notes	Places	Enseignement	Notes	Places
Doctrines chrétiennes	<u>9</u>		Marialogie	<u>7</u>	
Vie intérieure	<u>8</u>		Histoire sainte et ecclés	<u>7 1/2</u>	
Catéchisme religieux	<u>8</u>		Pédagogie		
Constitutions	<u>7</u>		Ecriture	<u>7</u>	
Oraison	<u>9 1/2</u>		Chant	<u>9</u>	
Evangile	<u>9 1/2</u>			<u>8</u>	

Place moyenne de l'examen : 18 sur 21 novices { 8 lettrés (3) ouvriers }

Observations spéciales :

Appréciation générale du sujet : This candidate shows good will, he applies himself well to studies. He is not lacking piety.

Le Maître des novices,
Geo. Meyer

(1) Janvier, avril, juillet. — (2) Nom, puis prénom usuel. — (3) Biffer l'un des deux mots.

J. M. J.

Noviciat de

Mt St John

Bulletin du 1^{er} (1)

April

1935

M. (2) *Pleiman Bernard* né le *April 10* 1917

à *Noviwood, O.*, dép^t d.

Entré au postulat le *Aug. 14* 1933

A commencé son noviciat le *Aug. 14* 1934

Notes générales

Constitution	<i>strong</i>	Application à l'étude	<i>good</i>
Taille	<i>1.77</i>	Esprit de foi	<i>never fail</i>
Santé	<i>good</i>	Id. d'obéissance	<i>good</i>
Extérieur, tenue	<i>scholar</i>	Id. de pauvreté	<i>"</i>
Politesse	<i>good</i>	Id. d'abnégation	<i>"</i>
Jugement	<i>correct</i>	Id. de charité	<i>"</i>
Caractère	<i>decided</i>	Id. de famille	<i>has some</i>
Attach. à la vocation	<i>never good</i>	Docilité à la correction	<i>yes</i>
Ouverture	<i>frank</i>	Facultés saillantes	<i>none</i>
Piété	<i>scholar</i>	Aptitudes particulières	<i>scholar</i>
Régularité	<i>good</i>	Défauts saillants	<i>nothing special</i>
Silence	<i>pretty "</i>		

Enseignement	Notes	Places	Enseignement	Notes	Places
Doctrines chrétiennes	<i>8</i>		Marialogie	<i>8</i>	
Vie intérieure	<i>8</i>		Histoire sainte et ecclés.	<i>8</i>	
Catéchisme religieux	<i>8 1/2</i>		Pédagogie		
Constitutions	<i>9</i>		Ecriture	<i>7</i>	
Oraison	<i>8</i>		Chant	<i>7</i>	
Evangile	<i>8</i>		<i>Devotion</i>	<i>9</i>	
<i>Latin</i>	<i>4</i>		<i>Liturg</i>	<i>9</i>	
Place moyenne de l'examen : <i>16</i>			sur <i>24</i> novices		<i>lettrés (3)</i> <i>ouvriers</i>

Observations spéciales :

Appréciation générale du sujet : *This novice is ordinary, he is not very talented. Somatisme lacks seriousness, but shows faint spirit.*

Le Maître des novices,
Geo. Meyer

(1) Janvier, avril, juillet. — (2) Nom, puis prénom usuel. — (3) Biffer l'un des deux mots. (21)

J. M.
Noviciat de St John

Bulletin du 1^{er} (1) Jan 9 1935

M. (2) Reiman Bernard né le April 10 - 1927

à Norwood O. dépt de

Entré au postulat le Aug. 14 1932

A commencé son noviciat le Aug. 14 1934

Notes générales

Constitution.	<u>strong</u>	Application à l'étude .	<u>fair</u>
Taille	<u>1m 76</u>	Esprit de foi	<u>seems good</u>
Santé	<u>good</u>	Id. d'obéissance	<u>good</u>
Extérieur, tenue	<u>ordinary</u>	Id. de pauvreté	<u>"</u>
Politesse.	<u>good</u>	Id. d'abnégation	<u>"</u>
Jugement	<u>fair</u>	Id. de charité	<u>"</u>
Caractère	<u>somewhat childish</u>	Id. de famille	<u>has some</u>
Attach. à la vocation	<u>seems good</u>	Docilité à la correction.	<u>yes</u>
Ouverture	<u>frank</u>	Facultés saillantes	<u>none</u>
Piété.	<u>ordinary</u>	Aptitudes particulières.	<u>ordinary</u>
Régularité	<u>good</u>	Défauts saillants	<u>nothing special</u>
Silence	<u>fair</u>		

Enseignement	Notes	Places	Enseignement	Notes	Places
Doctrines chrétienne	<u>8½</u>		Marialogie	<u>7½</u>	
Vie intérieure	<u>7½</u>		Histoire sainte et ecclés.	<u>8</u>	
Catéchisme religieux	<u>8</u>		Pédagogie		
Constitutions	<u>6</u>		Ecriture	<u>7</u>	
Oraison	<u>8</u>		Chant	<u>8</u>	
Évangile	<u>8</u>		<u>drawing</u>	<u>8</u>	
	<u>7</u>		<u>liturgy</u>	<u>7</u>	

Place moyenne de l'examen : 70 sur 144 novices } lettres ouvriers (3)

Observations spéciales :

Appréciation générale du sujet : Ordinary novice. He is docile, fairly pious. He could study harder.

Le Maître des novices,
Geo. Meyer

(1) Janvier, avril, juillet. — (2) Nom, puis prénom usuel. — (3) Biffer l'un des deux mots. (21)

MOUNT SAINT JOHN NOVITIATE

R. D. NO. 12 -- BOX 71

Dayton, O., *May - 15 - 1934*

CANONICAL INFORMATION REGARDING

..... *Bernard Reiman*

Born *April 10th 1917*

at *Newwood, Ohio*

Archdiocese or ~~Diocese~~ *of Cincinnati*

Son of *Charles Reiman*

and *Mary Sauer*

Please furnish information on the following points concerning the above named applicant

1. Birth

2. Conduct

3. Character

4. Life

5. Reputation

6. Social Status

7. Learning

8. Canonical Impediments

9. Financial Obligations

10. Other Personal Obligations and Responsibilities

11. Other points mentioned in Canons 544 and 545 of the New Code

Date..... *May 17 - 1934*

Signature..... *Henry A. Ruse*

OMNIBUS HAS LITTERAS VISURIS
SALUTEM IN DOMINO

Cum dilectus in Christo filius *Bernardus Pleinan*
filius leg *itimus Caroli Pleinan*
ejusque uxoris, *Mariæ Sauer*
natus die *11^{te}* mensis *Aprilis* anno *1917*
in parochia *S^{an}c^ti Petri & Pauli Norwood* dioecesis *Cincinnatiensis*
in Societatem B. V. Mariæ admitti intendat: r

Hisce litteris juxta scientiam Nostram ex diligenti investigatione, ad tenorem C. 545,
deductam, testamur:

Nihil in aspirantis natalibus, moribus, ingenio, vita, fama, conditione, scientia, obstare
quominus supradictam Societatem ingredi valeat, ipsum nullo modo esse inquisitum, alicui
censuræ, irregularitati aut alio canonico impedimento irretitum; neque propriam familiam
ejus auxilio indigerè.

Datum in Urbe Nostra *Cincinnatiensis* archi episcopali,

die *29* mensis *Junii* A. D. 1934.

de mandato etc
Josephus H. Albers
Episcopus Aua Cincinnatiensis

000116

Certificate of Confirmation

The Records of this Church Certify, under date of Nov 16 1924
that Bernard Pleiman SON
of Charles Pleiman and Mary Sauer DAUGHTER,
born Apr 10 1917, and baptised April 15 1917,
in S. S. Peter & Paul Church, located Norwood Ohio,
was Confirmed by the Most Rev. Archbishop Moeller D.D.
with Sponsor Earl Pleiman.

Rev. Henry H. Duse

Date July 2 1932

SEAL OF
CHURCH

A. J. EGGERS & CO., PRINT. CINCINNATI, O.

Baptismal



Certificate

The Records of this Church Certify, under date of Apr. 15 1917
to the Baptism of Bernard F. Pleiman, born Apr 10 1917
of Charles Pleiman and Mary Sauer.

Said Record is signed by Rev. Bernard J. Dickmeyer
with sponsors, John Sudkamp and Alma Sauer

Rev. Henry H. Duse

Date, July 2, 1932

000117
CHURCH SEAL
HERE

EGGERS & CO., PRINT. CINCINNATI

St. Anthony's Church,
Rev. F. A. Kehoe, Pastor.

Bellevue, Ky., February 2 1916

This is to certify that on the 6th of February, a. d. 1901,
Charles Pleimann of Cincinnati, Ohio, and Mary Sauer
of Bellevue, Ky., were united in the bonds of matrimony
by Rev. Thomas M. Grady, at Bellevue, Ky., in the presence
of Gus Sauer, Jr. and Helen Sauer

Rev. Francis A. Kehoe, Pastor,

000118

OFFICE PHONE
NORWOOD 532

OFFICE HOURS
8-9 A. M. 1-2:30 P. M.
6:30 - 8 P. M.

FRANK PERRY, M. D.

"The Maple"

NORWOOD, OHIO

To whom it concerns: 7-14-37

This certifies that Bernard
Blissman has been examined
by me and found to be
in good physical condition.
Has no contagious disease
and has not been exposed

Yours very truly,
Frank Perry, M.D.

000119

Name	Bernard Thomas Plimann
Father's Name	Charles Plimann
Mother's "	Mary Sauer
Address	2208 Hannaford Ave
City & State	Norwood Ohio
Born	April 10, 1917
Baptism	April 15, 1917
Confirmation	Nov. 16, 1924
Date of Entrance	Aug 1, 1932

000120

NAME PLEIMANN Bernard Thomas of the Diocese of Cincinnati
 (Family Name) (Christian Name)

GENERAL INFORMATION

Father's Name Charles Pleimann (RIP) Address _____
 Mother's Name Mary Kreke Sauer (RIP) Address 1220 Webster Ave Deer Park Cincinnati Ohio
 Guardians's Name CLIFF PLEIMANN Address 1933 CORDOVA AVENUE
BROTHER N. COLLEGE HILL, CIN OH
 Entered Postulate at Mt St John Date of Entrance 8/1/32
 Entered Novitiate at Mt St John Date of Entrance 8/14/34

Temporary Vows		
Place	Date	Term
Mt St John	8/15/35	1 yr
" "	7/11/36	1 yr
Santa Cruz	7/19/37	1 yr
Hono-SLHS	7/31/38	1 yr
" "	7/16/39	1 yr

Province of the Pacific

Birth Place Norwood Ohio Date 4/10/17
 (City) (State)
 Baptism Place Norwood Ohio Date 4/15/17
 (City) (State)
 Confirmation Place Norwood Ohio Date 11/16/24
 (City) (State)
 Perpetual Vows Place Honolulu Hawaii Date 7/7/40
 (City) (State)
 Ordination Place _____ Date _____
 (City) (State)
 Death Place _____ Date _____
 (City) (State)
 Withdrawal Place Yokohama St. Joseph T (P) Date 5/7/38
 (City) (Establishment)

NAME PLEIMANN Bernard Thomas

000121

NAME

Province of the Pacific

PLACES AND EMPLOYMENTS

Date	Place	Employment	Director
8/16/35	Mt St John	Scholastic	Rauscher Rev J
(for 1936 - 1953 see personal folder)			
1956	Gardena	Teacher	Bro J Hoffman
1960	"	"	Bro F Spaeth
1962	SLHS-Honolulu	"	Bro J Wipfield
6/65	" "	"	Bro V Steele
8/69	Riordan-SF	"	Br. O Aiu
8-70	St. Joe Yokohama	Teacher	Fr. F. Gerber

Academic Degrees

Degree	Subject	Conferred	
		Date	Place
BS	Education	1952	Dayton U

REMARKS

000132

Name Bernard T. Pleimann
 Date and Place of Birth April 10, 1917 Norwood, Ohio
 Date and Place of First Profession Aug. 15, 1935 Mt. St. John
 Date and Place of Perpetual Profession July 1940 St. Louis College
 Date of Arrival in Hawaii Aug. 26, 1937 Aug. 26 1946

Names and Addresses

Mrs. C. Pleimann 2208 Hannaford Ave.
Norwood, Ohio
4220 Webster Ave. Deer Park,
Cincinnati, 36, OHIO

Places of Teaching and Year
 Mark the year double 1883-84

<u>1936 - 37</u>	<u>St. James San Francisco</u>
<u>1937 - 39</u>	<u>St. Marys Kilo</u>
<u>1939 - 40</u>	<u>St. Louis College Honolulu</u>
<u>1940 - 42</u>	<u>Cathedral School</u>
<u>1942 - 45</u>	<u>St. Louis College</u>
<u>1945 - 46</u>	<u>St. Johns Home</u>
<u>1946 -</u>	<u>St. Louis College</u>

Oleimann, Bro. Bernard J.

Bernard, Bro.

Born April 10, 1917. First Vows Aug. 15, 1935. Perpetual Vows July 7, 1940. Came to Hawaii Aug. 26, 1937. ^I ^{II} Aug. 26, 1946

Year	Class or Occupation	Year	Class or Occupation
1939-40	Grade 4-A. Flag		
— —	— Cathedral Sch, Hon. —		
1942-43	Grade 6-C.		
1943-44	Grade 6-B.		
1944-45	Grade 7-C.		
— —	To St. John's Home, Brooklyn		
1946-47	Grade 5-A.		
— —	To Hilo.		
1951...	Dayton		
1952-1962	Gardena		
1962 -			

University of Dayton

DAYTON, OHIO

OFFICE OF THE REGISTRAR April 29, 1949

Official Transcript of the Record of Bro. Bernard Fleimann, S.M.

Address _____

Date	Course No.	DESCRIPTION	Sem. Hrs.	Grade
HONOLULU SUMMER SCHOOL - 1939				
	Ger. 101	Elementary German	3	B
	Psych. 201	Introductory Psychology	3	B
1939-40	301	U. S. History 1492-1852	3	B
	312	Logic	2	B
S-1940	201	Introductory Psychology	3	C
	201	Principles of Economics	3	C
2/1/41		Logic	1	D
1940-41	303	Human Physiology	(3)	aud.
	106	Analytical Geometry	(3)	aud.
S-1941	Art 201	Principles of Design	2	A
S-1942	Math. 201	Differential & Integral Calculus	4	B
	G.E. 101	Engineering Drawing	3	C
S-1944	Educ. 410	Seminar in Teaching of Religion	2	B

Elmer C. Lackner, S.M.
Registrar.

3000-8-10-46

000125

Society of Mary Province of the Pacific
PERSONNEL RECORD
 Name Pleimann, Bernard A Thomas

Degree B.S. IN ED.
 Date 1952
 Degree U.D.
 Date _____

Date of Birth Apr. 10, 1917 City Norwood, State Ohio.
 Home Address in Case of Emergency Mrs. Mary Pleimann, (mother) 4220 Webster, Deer Park, Cincinnati, Ohio
 Entered Postulate at Mount St. John Aug. 1, 1932
 Entered Novitiate Aug. 1, 1934
 First Vows Aug. 15, 1935
 Perpetual Vows July, 1940 ST. 4

Name _____
 Date _____ University _____ Cr. Hr. _____ Grade _____
 Subject _____

Date	University	Subject	Cr. Hr.	Grade	Date	City	School	Class
1953	South. Cal.	Sec. Math from Advanced Standpoint	3	B	1936-37	San Francisco, Hilo	St. James	4 Gr.
1954-S	South. Cal.	Theory of Numbers	3	B	1937-39	Honolulu	St. Mary	4 Gr.
1954-55	South. Cal. 435	Vector Analysis	3	B	1939-40	Honolulu	St. Louis College	
1955-56	U.S.C.	Higher Math for Physicists & Engineers	(3)	F	1940-42	Honolulu	Cathed. Sch.	
1957-58	U.S.C.	PHYSICS	3	A	1942-45	Honolulu	St. Louis College	
1958-59	U.S.C.	PHYSICS	3	A	1945-46	Brooklyn	St. John's Home	
1959-60	U. OF ARIZONA	SC. + MATH (M.S.F.)	7	A	1946-47	Honolulu	St. Louis College	
1959-60	LOYOLA U.	EXPER CHILDREN	3	A	1947-51	Hilo	St. Mary	
1960-61	SERRA	TEACH - SS			1951-52	Dayton	Univ. of Dayton	Student
1961-62	U. OF ARIZONA	SUMMER INST. (N.S.F.)	4-4	B+ A	1952-52	San Francisco	Riordan	Student
1962-63	ST. LOUIS HS, HONOLULU	TEACHING			1952-52	Gardena	Serra H. S.	
SS 1963	Arizona, U.	NSF GRANT			1952-52	Honolulu	St. Louis	

000126

ACADEMIC RECORD UNDERGRADUATE

Degree B.S. IN ED.

Name _____ Date JUNE, 1952 U.S.A.

ACADEMIC RECORD UNDERGRADUATE

Degree _____

Name _____ Date _____

Name	Date	Course No.	Subject	Cr. Hr.	Grade
			CONSTITUTION EXAMINATIONS		
			RELIGION EXAMINATIONS		

Foreign Language				History				Mathematics			
Eng-lish	Fr.	Ger.	Sp.	Lat.	Anc. Mod.	Med. Eur.	U.S. Civ.	Arith.	Alg.	Geo.	Trig.

Science				Econ. and Man.				Misc. Total				
Ch'm	Bot.	Zoo.	Biol.	Gen. Agr. Sci.	Geog.	Mus. Subj.	Soc. Tr.	Draw.	Dom. ing.	Sci.	Misc.	Total

Name	Date	Course No.	Subject	Cr. Hr.	Grade
			CALIFORNIA SECONDARY CREDENTIAL (MATHEMATICS)		
			Valid to		
			Valid to		
			HAWAII TEACHING LICENSE		
			No.		

000127

UNIVERSITY OF DAYTON
DAYTON, OHIO
OFFICE OF THE REGISTRAR

Date: June 2, 1952

Name PLEIMANN, (Brother) Bernard Thomas, S.M. Date of Birth 4-10-17

Address 175 Phelan Avenue City San Francisco 12 State California

Your application for admission together with your transcript of credits from _____ has been received.

ENTRANCE CREDITS: _____ Graduated _____

Name of High School		Location		SUBJECTS		SUBJECTS		SUBJECTS	
SUBJECTS	UNITS	SUBJECTS	UNITS	SUBJECTS	UNITS	SUBJECTS	UNITS	SUBJECTS	UNITS
English		Economics		Gen. Science		Phys. Geography		Com. Law	
Latin		Sociology		Chemistry		Agriculture			
French		Algebra, Elementary		Physics		Bookkeeping			
German		Algebra, Advanced		Biology		Stenography			
Spanish		Geometry, Plane		Botany		Typewriting			
History		Geometry, Solid		Zoology		Com. Arithmeti:			
Civics		Trigonometry, Plane		Physiology		Com. Geography		Total	

Advanced standing:

Acceptable credits from:

University of San Francisco:

1951-1952	Math. 108	History of Mathematics	2	A
2nd. Semester	Math. 115	Modern Trends in Higher Algebra	3	B
	Educ. 111	Child Growth & Development	2	B
	Educ. 125	Audio-Visual Techniques	2	A
	Educ. 245	Seminar in Secondary Curriculum	2	A

11 Semester Hours

Please add these credits to the record of Brother Pleimann, student in the Division of Education.

000128

Sincerely,

Your academic standing will be

Charles J. Collins, S.M.
Dean and Registrar

SCHOLASTIC RECORD OF

Pleimann, Bernard F. S.M.

UNIVERSITY OF DAYTON

COLLEGE OF

Entered Sept. 1934

Degree B. S.

OFFICE OF THE Inspector

Home Address Mt. St. John, Dayton, Ohio.

Date June, 1952

DEPARTMENT	Course No.	DESCRIPTIVE TITLE	1st Sem.		2nd Sem.		DEPARTMENT	Course No.	DESCRIPTIVE TITLE	1st Sem.		2nd Sem.	
			Hrs.	Gr.	Hrs.	Gr.				Hrs.	Gr.	Hrs.	Gr.
1934-35		FIRST YEAR					1948-S	SLC					
Eng.	101, 102	English	2	B	2	B	Eng.	423	Tragedies of Shakespeare	3	B		
Lat.	101, 102	Latin	2	B	2	B	1944-S	SLC	Sem. in Teaching Religion	2	B		
Hist.	203	History	3	B	3	B	1949-S	SLC	Teaching Science in HS.	3	A		
Ethics	303	Ethics	2	B	2	B	Educ.	411	Educ. Psy.	3	B		
Edu.	201	Education	2	B	2	B	1051 - 1950	Unit of Dayton	Prin. of Teach.	3	A		
		Sac. Scripture	2	B	2	B	Educ	202	Mental Hygiene	3	B		
		Drawing	2	B	2	B	Educ	307	Can. Physics Lecture	3	B		
Apolog.	201, 202	Apologetics	-	-	-	-	Psy	305	Lab	1	A		
Dogma	101, 102	Dogma	-	-	-	-	Psy	206	Gen. Biology Lecture	3	B		
		Music	-	-	-	-	Bio	101	Lab	1	A		
1935-36							Math	201	Diff & Int Calculus	(4)	Auditor		
Eng.	101, 302	English	3	B	3	B							
Germ.	201, 202	German	3	B	3	B							
Hist.	204	History, Modern	2	B	2	B							
Math	103	Trigonometry	4	A	-	-							
Chem.	101, 102	Chemistry, Gen.	3	C	3	B							
Edu.	303	Education, Org. & Mgm.	2	B	-	-							
Edu.	304	Education, Tests & Meas.	-	-	2	B							
Math.	104	Analytic Geometry	-	-	4	B							
1939 Summer		SECOND YEAR											
St.Louis C.	Germ. 201	Elementary German	3	B									
T.H.	Phil. 201	Psychology, Intro.	3	B									
1938-39													
Math		Algebra	6	B									
1939-40													
U D and	Hist. 301	U S Hist. 1492-1852	3	B									
St.L.C.	Phil. 312	Logic	2	B									
1940 Summer													
U D and	Phil. 201	Intro. Psychology	3	C									
St.L.C.	Econ. 201	Prin. of Economics	3	C									
1941-S													
St.L.C.	Art 201	Principles of Design	2	A									
1941-42	Math 107-8	Algebra	6	A									
St.L.C.	Phil. 312	Logic	1	D									
1942-S													
Math.	201	Diff. & Integr. Calculus	4	B									
G.E.	101	Engineering Drawing	3	C									

000130

Graduated from
Mt. St. John Normal
Prep.
Dayton, Ohio.
1934

ENTRANCE CREDITS

Units

English: 3

History, Civics:
American 2
1

Mathematics:
Algebra 1 1/2
Geometry 1 1/2

Science:
Chemistry 1
Physics 1

Languages:
Latin 3
German 2

Other Topics:

CONDITIONS

REGISTRATION RECORD

Name Pleimann, Bernard F. S.M.

Address

Date of Birth Apr. 10, 1917

Town

State

Church Affiliation

Father's Name

Mother's Name before Marriage

Withdrew

Re-entered

Transcript of Record sent to:

- 1.
- 2.
- 3.

Has Honorable Dismissal

Distinction in Graduation

OTHER MEMORANDA
Religion marks C.B
1940 Sacred History B
1941 Eccles. History 70
1943 Summa Vol. I 70
1944 Summa Vol. II-1 72

CUMULATIVE HOURS AND POINTS

YEAR	1st Semester		2nd Semester		Total		Point Average
	Hours	Points	Hours	Points	Hours	Points	

MARKING SYSTEM

- A—Excellent3 points;*
- B—Good2 points;
- C—Average1 point;
- D—Poor, but Passing.....0 point;
- E—Conditioned0 point;
- F—Failed0 point;
- I—Incomplete0 point.

* For each semester hour allowed for the course.

000131

Page 2.

Father: RIP

Mother; Mary

Address: 4220 Webster Ave.
Deer Park,
Cincinnati, 36, Ohio

Herbert:

Address. 6920 Kenwood Road
Cincinnati, 43 Ohio

Clifford and Earl the same addresses as on sheet

Mabel : Crane School House Road
Bethel, Ohio

Evelyn lives with my mother.

0001.22

CURRENT PERSONNEL RECORD

Province of Cincinnati

Society of Mary

Name: *Heimann, Bernard* Birth: Apr 10 1917 City: Norwood State: Ohio

Apr. 10 1917 Norwood Ohio

Degree:

Date:

College:

Graduate Work. College:

Field:

Cr. Hrs.:

Teacher's
Certificate:

Type:

Date:

Grade:

Number:

Teaching Fields:

Special Aptitudes:

000133

ANECDOTAL RECORD

Name: *Pleimann, Ralph.*

Date-School

Observations

*Nov 4-10, 47
St. John's Home*

SLC
Jan 15 1947

11/12/48 Hll

*Counselor - 3, not discerning; dissects -
find with weak attitude in chapel not
edifying; anxious to return to Hawaii.*

Lackadaisical, slovenly, a lone wolf. Teaches a good class; has great influence on boys. Accused of drinking, (bottles in room) but never substantiated. No/much interest in higher studies; relig. life mediocre. enig

*Likes math. Teaches a good class in it.
Teaches the boys to study by insistence
on main thought.*

0001.74

Ship and Travel **NORTHERN PACIFIC**

ROUTE OF THE *Vista-Dome* NORTH COAST LIMITED

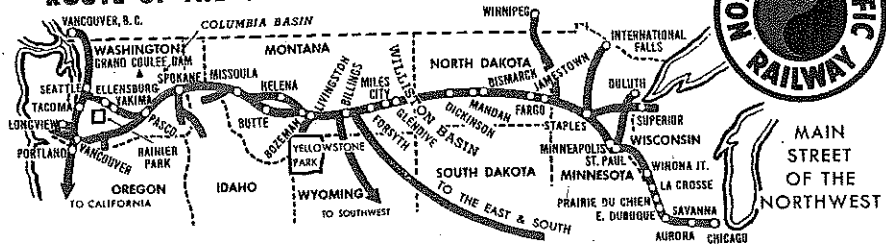

B. P.

Summer last. 1958

U of Chicago

NSF - Mathematics

000135

Birth	1917	April 10	Norwood, Ohio
TP	1935	Aug. 15	
EP	1940	July -	
DOD	6/14/1986		
Mrs. Charles Fleimann (mother)			
2208 Hannaford Ave.			
Norwood, Ohio			

000136

FLEIMANN, BERNARD F.

1948 St. Mary's, Hilo
1949 St. Joseph, Hilo
1950 St. Joseph, Hilo
1951 University of Dayton
1952 Junipero Serra, Gardena, California
1953 Junipero Serra, Gardena
1954 Junipero Serra, Gardena

000137

by the Monastic Communities
of Honolulu.

Mass of Resurrection for Bernard Pleiman
Mystical Rose Chapel, 7:00 PM. Tuesday, May 1, 1990

1. Entrance Song: We Remember #369 (Refrain/1st Verse/R.)
2. Readings from Holy Scripture
First Reading: Isaiah 25: 6a-7 to 9
Response: The Lord is My True Shepherd #262
Second Reading: I Corinthians 15: 20-23
Alleluia: #351(Verse 3)
Gospel of John 14: 1-6
3. Homily
4. General Intercessions
5. Offertory
6. Holy, Holy, Holy #531
7. Memorial Acclamation: Missalette page 50, 8B
8. Amen (following the doxology)

3. A - men, al - le - lu - ia, for -
ev - er and ev - er, for - ev - er, al - le - lu - ia, for -
ev - er and ev - er. A - men.

9. Recite the Lord's Prayer
10. Recite the Lamb of God
11. Communion Song: I Am the Bread of Life #276
12. Reflections by Brother Bill Schmitt
13. Final Commendation
14. Recessional Song: We Remember #369 (Refrain/4th Verse/R)

BRO. BERNARD PLEIMANN, S.M.

Bro. Pleimann's Obituary April 1940

Brother Bernard Pleimann, S.M., was born in Norwood, Ohio, shortly after the start of World War I. He received his elementary education at SS. Peter and Paul in that city. After a year at Purcell High School in Cincinnati and two years as a postulant in Dayton, he entered the Society of Mary's Novitiate in 1934. He professed his first vows on August 15, 1935.



Bro. Pleimann

His first teaching assignment (1937) was at St. James, San Francisco, where he taught the fourth grade. After a year in California he was sent to St. Mary's in Hilo, followed by a year at St. Louis College. He made his final vows in the St. Louis College Chapel in June 1940. After two years at Cathedral School, he returned to St. Louis College where he taught for the remainder of the years of World War II.

With the grade school on half day sessions, he organized a Victory Garden where he and a group of boys raised bumper crops of string beans and potatoes besides trying their luck at papayas, corn and peanuts. One of the highlights of their victory enterprise was the visit of the late Major Lester Petri who came to congratulate and encourage the boys in their project.

He returned to the mainland in 1945 aboard the SS Permanente under wartime restrictions with the first group of Brothers to visit their homes since the start of the war. After a year at St. John's Home in Brooklyn he returned to the Islands and St. Louis College. In 1947 he was appointed to St. Mary's in Hilo which later became St. Joseph's High School. Here he spent four years as math teacher, athletic director, and seismological observer for the Hawaiian Volcano Observatory. For his active work in seismology he won membership in the Seismological Society of America and the American Geophysical Union. He was in the last group of Brothers teaching in Hilo.

After a year of study at the University of Dayton and the University of San Francisco, he was

appointed to be math instructor at Junipero Serra High School in Gardena, California. Here he has shown great interest in the Advanced Math Program for Secondary Schools. He has been awarded National Science Foundation membership to two Summer Institutes — in 1958 to the University of Chicago and in 1959 to the University of Arizona.

000139

P.O. Box 772

ST. MARY SCHOOL
507 Waiianuanue Ave.
Hilo, Hawaii

Telephone 2388

FACULTY - 19__19__

NO. _____

I. Profession

Name: BERNARD T. PLEIMANN Surname: BERNARD

Name Day: AUGUST 20 St. BERNARD

Date of birth: APRIL 10, 1917 Place: NORWOOD, OHIO

Present Home Address: 2208 HANNAFORD AVE. NORWOOD

Date entered Postulate: AUG. 1, 1932 Place: MT. ST. JOHN

Date entered Novitiate: AUG 1, 1934 Place: MT. ST. JOHN

Date of first profession: AUG. 15, 1935 Place: MT. ST. JOHN

Date of perpetual profession: JULY 1940 Place: HONOLULU

Date of arrival in Hawaii: AUG. 26, 1937 At: PIER II

Visits to Mainland: (Years only) 1. 1945 2. 51 3. 53

II. Teach. or Assignments

1. School: ST. JAMES' SF. CAL. From 1936 to 1937

2. School: ST. MARYS HILO From 1937 to 1939

3. School: S.L.C. From 1939 to 1940

4. School: CATH. SCHOOL HONA From 1940 to 1942

5. School: S.L.C. From 1942 to 1945

6. School: ST. JOHN'S HOME BKLN. From 1945 to 1946

7. School: S.L.C. From 1946 to 1947

8. School: ST. MARYS HILO From 1947 to 1951

9. School: U.D. + USF From 51 to 52

10. School: SERRA GARDENA From 52 to 62

11. School: S.H.S. From 62 to _____

12. School: _____ From _____ to _____

CCC140

Vade Mecum for Traveling

* * * * *

PROVINCE OF THE PACIFIC

No. 2968

March 30, 19 68

Brother PLEIMANN, Bernard is hereby authorized to go
from Honolulu to Cincinnati
from _____ to _____
for the purpose of visit and to remain there
_____ days _____ Lodge _____
Leave ? Return ?

* * * * *

NOTA BENE

1. "When a religious goes to a place where the Society has an establishment, he may not lodge outside the community, not even with his parents or relatives" (Const., Art 248). Religious are requested to notify Directors about their arrival several days in advance.

2. "Never should the lay religious consider himself a secular. If by his costume he differs less from the people of the world than the members of other Institutes, he is all the more bound to distinguish himself from seculars by a grave and modest exterior (Const., Art. 351).

3. "Mental and vocal prayers are performed preferably before the Blessed Sacrament" (Const., Art. 128). It is suggested that the Religious take with him his Formulary and a copy of the Imitation of Christ.

4. "No present is solicited; none is accepted unless for the community or for the chapel. Every personal present is refused" (Const., Art. 40).

5. "The Religious denies himself familiarities and every unbecoming liberty especially does he avoid persons of the other sex" (Const., Art. 46). "In the vigilance which he exercises over his senses and in the privations which chastity imposes he finds a source of merit and consolations" (Const., Art. 47).

6. "Mortification directs and sanctifies the use of the senses by the holiness of the intention. There is for the professed nothing beautiful, nothing agreeable or curious to see or hear solely for the purpose of procuring for himself some gratification, after the manner of the world. Worldly amusements, futile conversations, frivolous correspondence, or reading, pleasure

000141

excursions, exist no longer for him; he shuns such disedifying crowds as vain curiosity attracts sometimes even to the church" (Const., Art. 171).

7. "The Chapter decides that the Director, whilst giving the Religious his travelling money, shall also give him a written or printed note on which the religious shall give back at his return, properly filled out, with a detailed list of his expenses and the sum of money still remaining. This statute is applicable to all changes of residence involving expenses. The Vade Mecum is to be returned to the Provincial by the Director as soon as possible after the return of the Religious" (General Chapter of 1896, page 125.) (General Chapter of 1939, pages 374 and 375),

8. It is recommended to continue the laudable custom of saying the Litany of the Blessed Virgin before each journey for the personal safety of the Religious.

Amount received upon departure	100	00
Presents		
ITEMIZED EXPENSES	<u>100</u>	<u>00</u>
Transportation: Railroad		
Plane		
Boat		
Carfare and Taxi		
Tips Telephone		85
Meals	7	38
Postcards & stamps	34	70
Smokes & misc	1	37
Total Expenses	44	30
Balance given to Director upon return	56	70
Total	89	65

8/24/68
Date of return

V. Stello
Director

Provincial

(Director will please return Vade Mecum to Provincial.)

V. M. of _____

000142

J M J
PROVINCE OF THE PACIFIC
INFORMATION SHEET
ON VISITS HOME FOR - 19 68

2968

TO: Pleimann, Bernard AT: Marianist Community - Honolulu

1. Kindly fill in the exact dates of your proposed visit home with your relatives. There is a FOURTEEN (14) day visit home with TWO (2) days for travel. (NOTE: If you are a senior scholastic there is an EIGHT (8) day visit with TWO (2) days for travel.

DATES OF VISIT HOME: AFTER AUGUST

PLACE OF VISIT: CINCINNATI OHIO
city state

2. If your visit will necessitate visiting other cities, please indicate the other locations and reasons.

MULTIPLE VISITS IN NORTHWEST AREA FOR START

3. At what address will you be most easily reached during your visit? my brother
Mr. Herbert Pleimann
6940 Kenwood Rd.
Cincinnati, Ohio

4. We wish your trip to be as pleasant as possible within the limits of our restricted budget and the accommodations available. Ordinarily our travel is by plane. If you have a reason for a different mode of travel, please indicate here the mode of travel you desire and reason.

I do not care too much for air travel.
I would like to travel by Greyhound \$99 for 99 days
(this is more than 1/2 the cost of Air Plane)

000193

PLEASE FILL IN and RETURN ENTIRE FORM to the Provincial Office by 1 March 19 68. Thank you for your promptness which is necessary in order to make the most satisfactory travel arrangements, and to prepare the summer personnel.

PROVINCIAL APPROVAL: Bernard Pleimann Sm Date Approved: 3-25-68

RETURN INTACT—PART 3 will be returned with your Vade Mecum.

Vade Mecum for Traveling

* * * * *

PROVINCE OF THE PACIFIC

No. 63-16

17 May 63

195

Brother Bernard Pleimann is hereby authorized to go
from Honolulu to Arizona
from Ohin to _____

for the purpose of a regular visit and to remain there

11 days Lodge in community if convenient

Leave dates of visit: Return 24 Aug. - 4 Sept.

* * * * *

NOTA BENE

1. "When a religious goes to a place where the Society has an establishment, he may not lodge outside the community, not even with his parents or relatives" (Const., Art 248). Religious are requested to notify Directors about their arrival several days in advance.
2. "Never should the lay religious consider himself a secular. If by his costume he differs less from the people of the world than the members of other Institutes, he is all the more bound to distinguish himself from seculars by a grave and modest exterior (Const., Art. 351).
3. "Mental and vocal prayers are performed preferably before the Blessed Sacrament" (Const., Art. 128). It is suggested that the Religious take with him his Formulary and a copy of the Imitation of Christ.
4. "No present is solicited; none is accepted unless for the community or for the chapel. Every personal present is refused" (Const., Art. 40).
5. "The Religious denies himself familiarities and every unbecoming liberty especially does he avoid persons of the other sex" (Const., Art. 46). "In the vigilance which he exercises over his senses and in the privations which chastity imposes he finds a source of merit and consolations" (Const., Art. 47).
6. "Mortification directs and sanctifies the use of the senses by the holiness of the intention. There is for the professed nothing beautiful, nothing agreeable or curious to see or hear solely for the purpose of procuring for himself some gratification, after the manner of the world. Worldly amusements, futile conversations, frivolous correspondence, or reading, pleasure

000144

excursions, exist no longer for him; he shuns such disedifying crowds as vain curiosity attracts sometimes even to the church" (Const., Art. 171).

7. "The Chapter decides that the Director, whilst giving the Religious his travelling money, shall also give him a written or printed note on which the religious shall give back at his return, properly filled out, with a detailed list of his expenses and the sum of money still remaining. This statute is applicable to all changes of residence involving expenses. The Vade Mecum is to be returned to the Provincial by the Director as soon as possible after the return of the Religious" (General Chapter of 1896, page 125.) (General Chapter of 1939, pages 374 and 375),

8. It is recommended to continue the laudable custom of saying the Litany of the Blessed Virgin before each journey for the personal safety of the Religious.

Amount received upon departure	60	00
Presents <i>NSF</i>	680	00
	<u>740</u>	<u>00</u>
ITEMIZED EXPENSES		
Transportation: Railroad		
Plane		
Boat		
Carfare and Taxi		
Tips		
Meals		
<i>See itemized statement</i>	107	47
Total Expenses	407	47
Balance given to Director upon return	332	53
Total		

Sept. 4, 1963
Date of return

James Whiffield
Director

Seward M. Fulton
Provincial

(Director will please return Vade Mecum to Provincial.)

V. M. of *Bernard Pleinmann*

000145

Pleimann, Bernard

Vade Mecum for Traveling

PROVINCE OF THE PACIFIC

No. 587

June 9, 1958

Brother Bernard Pleimann is hereby authorized to go
from S.F. to Ohio (Cincinnati)
from Aug 3 to Aug. 24 (travel on Mon.)
for the purpose of Visit and to remain there
21 days Lodge _____
Leave _____ Return _____

* * * * *

NOTA BENE

1. "When a religious goes to a place where the Society has an establishment, he may not lodge outside the community, not even with his parents or relatives" (Const., Art 248). Religious are requested to notify Directors about their arrival several days in advance.
2. "Never should the lay religious consider himself a secular. If by his costume he differs less from the people of the world than the members of other Institutes, he is all the more bound to distinguish himself from seculars by a grave and modest exterior (Const., Art. 351).
3. "Mental and vocal prayers are performed preferably before the Blessed Sacrament" (Const., Art. 128). It is suggested that the Religious take with him his Formulary and a copy of the Imitation of Christ.
4. "No present is solicited; none is accepted unless for the community or for the chapel. Every personal present is refused" (Const., Art. 40).
5. "The Religious denies himself familiarities and every unbecoming liberty especially does he avoid persons of the other sex" (Const., Art. 46). "In the vigilance which he exercises over his senses and in the privations which chastity imposes he finds a source of merit and consolations" (Const., Art. 47).
6. "Mortification directs and sanctifies the use of the senses by the holiness of the intention. There is for the professed nothing beautiful, nothing agreeable or curious to see or hear solely for the purpose of procuring for himself some gratification, after the manner of the world. Worldly amusements, futile conversations, frivolous correspondence, or reading, pleasure

000146

* Originally my sister was suppose to
 drive me from Chicago to Cin. plans
 fell through when her husband's Co. cancelled

excursions, exist no longer for him; he shuns such disedifying crowds as ^{the} vain curiosity attracts sometimes even to the church" (Const., Art. 171).

7. "The Chapter decides that the Director, whilst giving the Religious his travelling money, shall also give him a written or printed note on which the religious shall give back at his return, properly filled out, with a detailed list of his expenses and the sum of money still remaining. This statute is applicable to all changes of residence involving expenses. The Vade Mecum is to be returned to the Provincial by the Director as soon as possible after the return of the Religious" (General Chapter of 1896, page 125.) (General Chapter of 1939, pages 374 and 375).

8. It is recommended to continue the laudable custom of saying the Litany of the Blessed Virgin before each journey for the personal safety of the Religious.

	N.S.F.	1.00	00
Amount received upon departure		50	00
Presents		5	00
		<u>65</u>	<u>00</u>
ITEMIZED EXPENSES			
* Transportation: Railroad		12	87
Plane			
Boat			
Carfare and Taxi		5	50
Tips & baggage checked		3	50
Meals & TIPS (15)		28	45
Souvenirs, stamps & stationery		6	75
Snacks & films		3	25
Total Expenses		60	32
Balance given to Director upon return		4	68
Total		<u>65</u>	<u>00</u>

8/25/58
 Date of return

Joseph J. Hoffman, S.M.
 Director

Provincial

(Director will please return Vade Mecum to Provincial.)

V. M. of Bro. Bernard Pleiman

000147

HILO SEISMOGRAPH STATION

By BERNARD PLEIMANN, S.M.

HISTORY

Just a little more than twenty-nine years ago the first seismograph station was established in Hilo, in the basement of one of the buildings of Saint Mary's School. It was of the single-component type, that is, it had one pendulum. Since the records could be made more valuable by means of an instrument with two components, mounted on bedrock, it was decided to install one at Hilo. Dr. Jaggar, then Director of the Hawaiian Volcano Observatory, made three seismographs. Two were sent to Alaska, and the other was destined for Hilo. In the summer of 1927 an underground vault was constructed in the south corner of Saint Mary's School property. The floor was on solid rock, and the heavy masses were hung in two corners. For years this location was ideal, since the temperature remained practically constant and outside disturbances were at a minimum. However, its peace was disturbed when Laimana Street was put through only fifteen feet away. The passage of every vehicle was then unavoidably recorded on the seismograph. Recordings of traffic can easily be distinguished from those of earth tremors; but if both occur at the same time, it may become difficult or even impossible to single out important phases of the earthquake, and thus the record becomes useless. Water seepage was also troublesome; after heavy showers the observer would find inches of water on the floor.

Earlier observers for this station were Brothers Matthias Newell, Albert Holtman, Maurice Sarver, and Edward Strauss, who preceded the present Director, Brother Bernard Pleimann. The scientists at the Volcano Observatory have often commented on the careful and exact work done by these teachers.

HILO'S NEW STATION

When Saint Joseph's School moved to its new location on Ululani Street, the time seemed propitious for moving the station. A place for it was found midway between Ululani and Kapiolani streets, about eighty feet from Hualalai Street. This would be far enough from traffic and in a place where, it was hoped, future developments would bring no new troubles. In July, 1949, the two concrete piers to hold the masses were made. The base of each is several feet below the surrounding surface. To prevent the expansion of the floor from putting pressure on the piers a space was allowed between piers and floor. The shelter was built by the Hawaiian Volcano Research Association, after the cement work had had a chance to age and settle.

The seismograph, constructed in 1947, was being used as a tiltmeter at the Volcano Observatory. After the shelter in Hilo was ready for the instrument, pressure began to show under Mauna Loa and Kilauea, and it was deemed advisable to postpone installation until the pressure eased. The new station was finally put into operation on October 23, 1950. It is operated as part of the network of the United States Geological Survey's Hawaiian Volcano Observatory. The coordinates are $19^{\circ} 43' 2''$ N and $155^{\circ} 51' 3''$ W.



Fig. 1. The new seismograph station at Hilo, Hawaii.

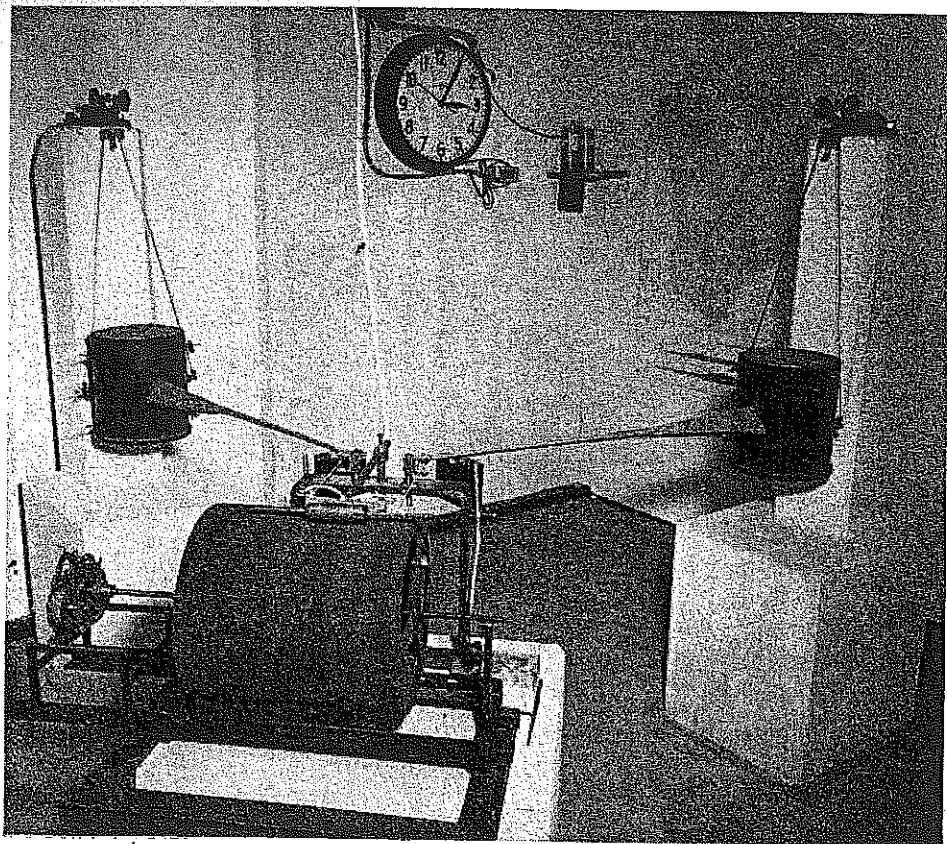

Fig. 2. The seismograph.

THE SEISMOGRAPH

The new seismograph, a modified Bosch-Omori, was built in the machine shop at the Volcano Observatory by Burton Loucks. Each of the lead-filled cylinders of this machine weighs 250 pounds. The horizontal pendulum hangs by a wire from the top of the pier. The bottom, equipped with a double pin, fits into a spring which is several inches inside of the pier. The free swinging period has been set at three

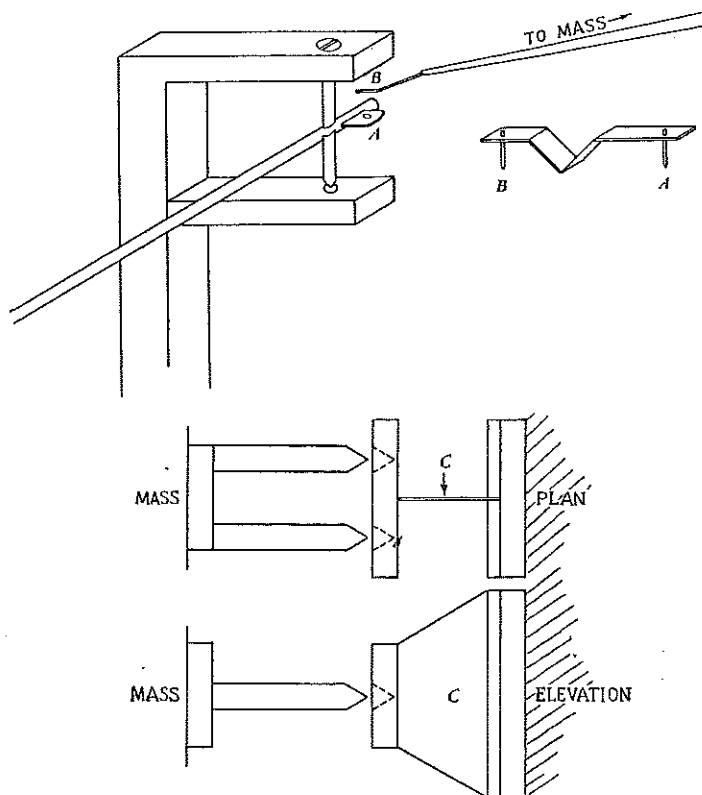

Fig. 3. Seismograph details: a, hinge at wall; b, pen lever system.

seconds, to increase sensitivity to local shocks. Oil damping is employed to steady the heavy masses. Magnification is 200; higher magnification is undesirable because of the frequent local earthquakes, one of which, occurring as recently as December 10, 1950, was so severe as to dismantle the instrument. To the mass is attached an aluminum boom stiffened by guy wires. At the end of the boom a loose, light aluminum bar is coupled to the writing arm. A stainless-steel needle set in jeweled bearings does the writing on smoked paper. The paper is wrapped tightly around a drum which is turned by an escapment clock set to make two revolutions an hour. A screw on one end of the drum makes it gradually move vertically. Time control is supplied by a Telechron clock. The paper is changed every twenty-four hours. Future plans call for an electrically driven clock revolving four times an hour. This

will necessitate an extra change of paper each day, but the extra attention required will repay itself with more accurate and more easily readable results.

NOTES ON THE SEISMOGRAPH

(Figures 2 and 3)

The roller-like device seen at the top of the drum is a coil to magnetize the bar to lift the needles every minute.

The diagram (drawn by Wilbert Chang) shows the writing arm. It is a hollow aluminum tube. The part behind the balancing pin is loaded to balance the forepart.

The bar is the couple between the writing arm and the boom. The V-shaped bend is on the bar so that weights in the form of washers may be added if the machine dismantles too easily.

Hinge device.—A cantilever spring is used. The mass is equipped with a double pin which fits into the bar that is connected to the spring.

Damping device.—The oil cups were "Spam" cans. The resistance is given by a thin double aluminum prong (2 by 3 ins.). The cups are attached to the frame of the drum support.

000151

University of Dayton

Office of the Registrar

The following is a statement
of the grades of Bro. B. Pleiman

of the Division of Education
Dean Bro. Faerber, S. M.

For the mid-semester ending November 10, 1951
semester ending

Dept.	Course No.	Title of Course	Credits—Grade
Educ	202	Educational Psychology I	B
Educ	307	Principles of Teaching	A
Psych	305	Mental Hygiene	A
Physh	206	Mechanics & Sound Lecture	A
		Lab	B
Bio	101	General Biology Lecture	B
		Lab	B
Math	201	Differential & Integral Calculus	Additor

Grades: A-Excellent; B-Good; C-Fair; D-Poor; I-Incomplete; F-Failed; WP-Withdrew, Passing; WF-Withdrew, Failure.
Point Values: A-4; B-3; C-2; D-1; I, F, WP, WF—0, for each credit hour.
At mid-semester the grades merely indicate progress; there are no point values;
F means Failing.

Elmer C. Lackner, Jr.

Registrar.

Parent or Guardian:

Bro. Paul Sibbing

PLEIMANN, Bernard

University of San Francisco

Spring 1952

Math	108	2	A
Math	115	3	B
Educ	111	2	B
Educ	125	2	A
Educ	245	2	A

000153

ST. LOUIS COLLEGE
Honolulu, Hawaii

Bro. Bernard Pleimann
Hopper Rd.
R.R. 8 Box 316
Cincinnati, 30, Ohio

July 19, 1951

000154

III. Relatives

- 1. Father: CHARLES Mother: MARY
Address: 2208 HANNAFORD AVE. NORWOOD, OHIO
- 2. Brothers: HERBERT Address: 5330 PANDACA AVE. CIN.
CLIFFORD Address: 1933 CORDOVA AVE. CIN.
EARL Address: 6924 WINDWARD MADISON P.
CIN., O.
- 3. Sisters: MABEL Address: 4 CHARMAIR FT. MITCHELL
KY.
EVELYN Address: 6937 BRITTON MADISON P.
CIN., O.

Address: _____

4. Other Relatives: (if none of the above are living):

Address: _____

Address: _____

Address: _____

IV. Education

- 1. Literacy: First School Attended: SS. PETER & PAUL
Place: NORWOOD, OHIO From 1923 to 1931
Other schools attended: _____
Place: _____ From _____ to _____
Place: _____ From _____ to _____
- 2. High School: High School Attended: PURCELL & MT. ST. JOHN
Place: CINCINNATI & DAYTON From 1932 to 1934
Graduated in 1934. Number of Credits: 18
College or University: MT. ST. JOHN
Place: DAYTON From 1934 to 1936

000155

Address: _____
 Address: _____
 Address: _____

Brother Tells Story Of Hilo Seismograph Station At St. Joseph's School *Leimann*

(The following article was written by Brother Bernard, S. M. of St. Joseph's High School in Hilo, Hawaii, who is in charge of the project discussed.)

HISTORY *Cath. Herald Nov. 30/50*

Just a little more than twenty-nine years ago the first seismograph station was established in Hilo. It was located in the basement of one of the buildings of St. Mary's school. It was a single component type, that is, it had one pendulum. Since the records could be made more valuable on an

instrument with two components, mounted on bed rock, it was decided to give Hilo such a one. Dr. Jaggar made three seismographs, two were sent to Alaska and the other destined for Hilo. During the summer of 1927 an underground vault was made in the south corner of St. Mary's property. The floor was on solid rock and the heavy masses were hung in two corners. For years this location was ideal for the temperature remained practically constant and outside disturbances were at a minimum. However, its peace was disturbed when Laimana St. was put through only 15 feet away. Every vehicle was then recorded. The recordings of traffic could easily be discerned from those of tremors, but if one passed while an earthquake was being recorded it might be very hard or even impossible to pick out important phases of the quake. This would make the record useless. Water seepage was another bother. After heavy showers the observers would find inches of water on the floor.

Past observers of this station were Brothers Albert Holtman, Matthias Newell, Maurice Sarver, Edward Strauss and Bernard Pleimann. The scientists at the Volcano Observatory have often commented on the careful and exact work done by these teachers.

HILO'S NEW STATION

When the Catholic school moved to its new location on Ululani St.,

the time seemed right to move the station. A spot was found midway between Ululani and Kapiolani about eighty feet from Hualalai. This would be far enough away from traffic and in a place where it is hoped that future developments will bring no new troubles. In July, 1949, the two concrete piers were made. The base of each is several feet below the surrounding surface. To prevent the expansion of the floor from putting pressure on the piers, a space was allowed between the piers and the floor. The shelter was built after giving the cement work a chance to age and settle.

* * *
The seismograph was constructed in 1947 and was being used as a tiltmeter at the Volcano Observatory. After the shelter was ready for the instrument, pressure began to show under Mauna Loa and Kilauea, so it was deemed advisable to wait until this eased.

THE SEISMOGRAPH

The new seismograph was built in the machine shop at the Volcano by Burton Loucks. It is a modified Bosch-Omori. Each of the lead-filled cylinders of this machine weighs 250 pounds. The horizontal pendulum hangs by a wire from the top of the pier. The bottom, equipped with a double pin, fits into a spring which is several inches inside the pier. The free swinging period has been set at three seconds so as to be more sensitive to local shocks. Oil damping is employed to steady the heavy masses. Magnification is 250. To the mass is attached an aluminum boom stiffened by guy wires. At the end of the boom a loose, light aluminum bar is coupled to the writing arm. A stainless steel needle set in jeweled bearings does the writing on smoked paper. The paper is wrapped tightly around a drum which is turned by an escapement clock set to make two revolutions an hour. A screw is on one end of the drum to make it move gradually vertically, thus preventing the needles from tracing the lines in the same place. The paper is changed once every 24 hours. Future plans call for an electrically driven clock revolving four times an hour. This will necessitate an extra change of paper each day. However, the added trouble will repay with more accurate and easier reading records.

000156

7-26-65

S.B.

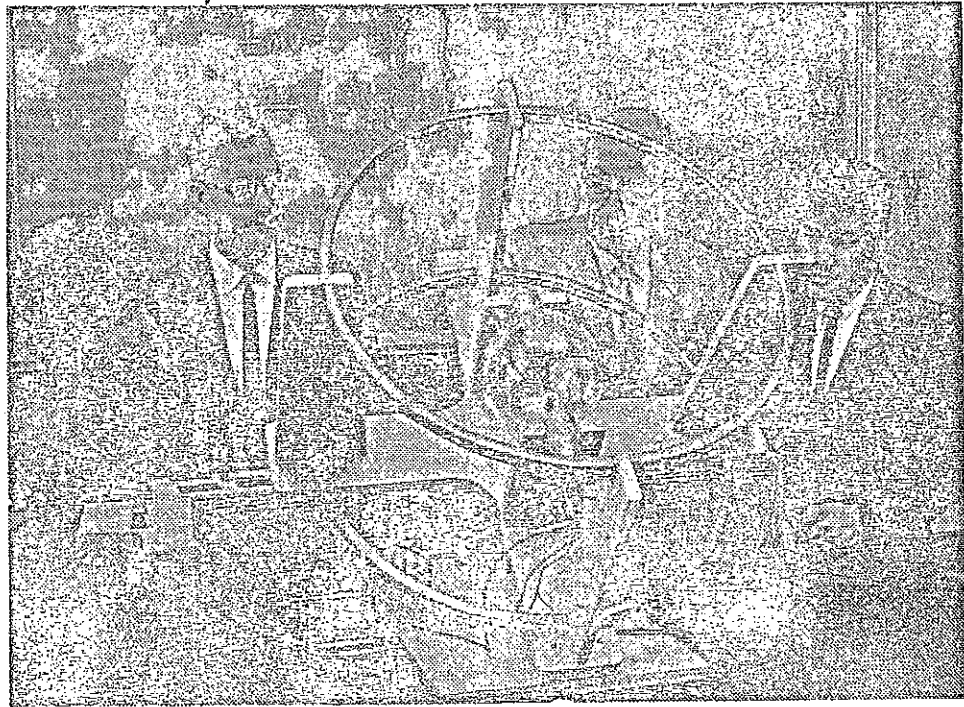

Three Islanders are among 50 high school science and mathematics teachers attending an eight-week seminar at Stanford University this summer, under a Shell Oil Company fellowship grant. From left: Mrs. Katherine H. Aratani of Kamehameha School for Boys; Brother Bernard T. Pleimann of St. Louis High School; Dr. John Streib, Stanford associate professor of physics, and Alvin J. K. Won of Kaimuki High School.

000157

CHAMINADE COLLEGE/ST. LOUIS HIGH SCHOOL/MARIANIST COMMUNITY
Public Relations Office

FACULTY AND ADMINISTRATION INFORMATION FORM

Mr. Miss Mrs. PLEIMANN, BERNARD T. Date 9/7/67
Last First Middle

Chaminade Faculty Staff
St. Louis Faculty Staff

Local address ST LOUIS Phone _____

Hometown _____ Appointed to faculty/staff June '62
City State Date

Birthdate 10/4/17 Place: Norwood Ohio
Day/Mo./Yr. (Held confidential if requested)

Department Math Faculty rank/title teacher

Educational background (begin with most advanced degree study):

Coll./Inst.	Field of study	Degree	Yr. Graduated
U. of Arizona	Math	MS	1964
Dayton	Ed	B.S. in Ed	1952

Name/location/graduation date/high school attended St. John
Dayton Ohio 1935

Faculty/staff committees _____

Special college/high school duties _____
(club moderator, advisor, etc.)

Professional memberships/offices held AM SEISM. Soc,
HALL MATH TEACHERS ; NAT. HI. SCH MATH TEACHERS

Fraternal & social org./offices held SHELL MERIT FELLOW ('65)

Previous teaching/other professional experience--institutions, dates, titles:

<u>Institution</u>	<u>Dates</u>	<u>Title/rank</u>
SERRA HI (Gardena Cal)	1952-62	HEAD OF MATH DEPT

Published books/papers, etc. _____

Special studies/research projects, avocations/hobbies _____

Military Service (branch/dty stn./rank/dates) _____

Marital Status (held confidential, if requested) _____

Name of wife/husband _____

No./children _____

FOR CLERICS AND RELIGIOUS ONLY:

Religious Organization: _____

SM

Date entered/place: _____

1931

Dayton

First vows/when/where: _____

1935

Dayton

Perpetual vows/when/where _____

1940

Penolville

Seminary training/when/where _____

Ordained/when/where _____

Special religious duties (other than teaching, etc.) _____

000159

Bro. PLEIMANN • By Tue A.M. please! Thanks Justice
 CHAMINADE-ST. LOUIS
 Development Office

Date 10/15/62

Faculty and Administration Information Form

Name Bro. Bernard T. Pleimann Chaminade _____ staff
 St. Louis

Local Address ST LOUIS Telephone number _____

Hometown Norwood, Ohio Date of appointment to faculty 6/15/62

Department MATH Present faculty rank HEAD OF DEPT

Educational background (list most recent first)

School	Major	Degree	Year granted
ARIZONA	MATH		
LOYOLA	ED.		
CHICAGO	MATH		
USC.	"		
USF.	EPT MATH	BS ED	1952
DAYTON	ED		

Name and location of high school attended Purcell (Cincinnati) Int St John Dayton
 Year of graduation 1934

Faculty committees HONORS Program

Special college or high school duties (moderator of clubs, etc.) MATH CLUB

Previous teaching or other professional experience (include names of institutions, dates)

- SERRA (GARDENA) 1940-52-62
- ST. JOHN HOME 45-41 BROOKLYN
- ST. VAS. ST. MARY'S 37-39 & 47-51 (HILO)
- ST JAMES 36-37 SAN FRAN.
- ST LOUIS COLLEGE '39-40 '42-'45
- CATHEDRAL SCHOOL (HONO) 39-40-42

Professional associations NAT. COUNCIL TEACHER OF MATH
~~Positions held~~ HAWAII MATH TEACHERS

Fraternal or Social Organizations _____
 Positions held _____

Published books, papers, etc. _____

Special studies, research projects, avocations _____

Military Service (branch, duties, dates) _____

For Religious: special religious duties (in Order or Diocese) _____

For lay members of faculty: Marital status _____

Name of wife or husband _____ Number of children _____

O R D E R O F S E R V I C E

(Numbers refer to pages in The Catholic Burial Rite)

1. Gathering of Friends of Josefina
2. Blessing of the Ashes (3)
3. Prayer (7)
4. A Reading from the Book of Wisdom (7)
5. Response to the Reading (8)
6. A Reading from the Book of Romans (8)
7. Alleluia sung by the Cantor
8. A Reading from the Gospel of John (9)
9. Homily
10. Prayer of the Faithful (10)
11. Eucharistic Prayer III (19-21)
12. Communion Rite (22) All who receive Communion in the Catholic Church are invited to partake of the Body and Blood of the Lord.
13. Prayer (25)
14. Final Commendation and Farewell (27, 29 & 30)

000161

+ + + + + + + + + + + + + + + + +

The second youngest of eight children, Josefina M. Pleimann was born in Hinunangan, Southern Leyte, in the Philippines. She was graduated from Holy Rosary Academy and then completed a two-year business program at the University of Visaya.

She married in 1974 and went with her husband to work at the Marianist St. Joseph High School in Yokohama, Japan. Their son was born on July 4, 1977, and Mr. and Mrs. Bernard Pleimann and Thomas moved to Honolulu in 1980.

As a member of the staff of the St. Louis-Chaminade Center Cafeteria, she formed lasting friendships with her associates, faculty and students.

Following a long period of hospitalization, Josefina died on Saturday, June 14, 1986. She is survived by her husband Bernard, their son Thomas, two brothers and a sister in Leyte and a brother and a sister in Mindanao. At her own request, she will be inurned with her parents at the place of her birth.



THE MASS OF RESURRECTION

for

JOSEFINA M. PLEIMANN

died on the fourteenth of June
nineteen hundred and eighty-six
Celebration of Resurrection
on

Wednesday, the eighteenth of June

Mystical Rose Chapel

Saint Louis-Chaminade Center

Honolulu, Hawaii

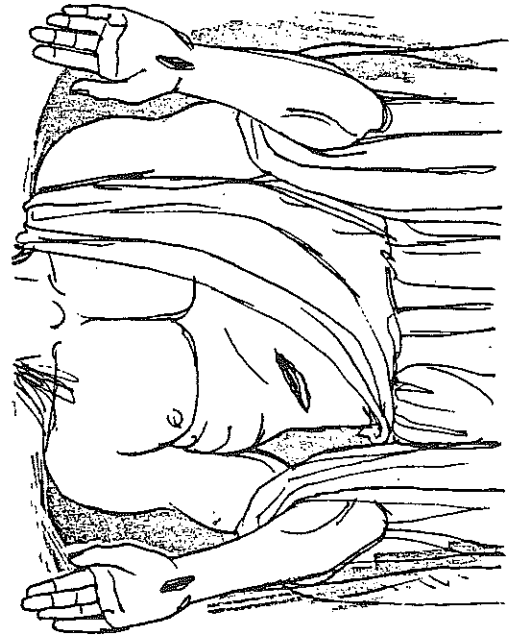

000162

J M J
MARIANIST PROVINCE OF THE PACIFIC
Office of Instruction

NAME: Brother Bernard Pleimann, S.M.

COMMUNITY: St. Louis High School

RESPONSIBILITIES:

Brother Pleimann teaches math in the high school. Brother Bernard still has difficulties in that he is partially deaf and refuses to wear a hearing aid. Brother Bernard tends to be somewhat critical and does not understand very many modern concepts in education. Unfortunately Brother Bernard tends to be rather independent - not fulfilling all the obligations of the other teachers - and is somewhat vocal in his criticism of school policies and administration. Brother Bernard will have a visit home this summer and hopes to get into somekind of a program in computer math.

DATE: _____ SIGNED: _____

000163

Bernard Pleimann, S.M.

49

St. Louis High School

Brother Bernard teaches five advanced mathematics classes. He has achieved the most outstanding success of all the teachers of mathematics in the State of Hawaii.

C
O
P
Y

000164

OFFICE OF INSTRUCTION
PACIFIC PROVINCE

BROTHER Bernard Pleimann AGE 48

SCHOOL St. Louis

OFFICE/COURSES TAUGHT Math Analysis, Algebra I, Jr. Math, Pl. Geometry (all Honors classes)

1. Strengths: extremely hard-working and reliable
Weakness: not very neat about his appearance
2. Has trouble staying awake during religious exercises, but has deep convictions
3. An outstanding teacher and a very successful one. He is a hard taskmaster for his students, but has the ability to "sell" his course and his enthusiasm for math is contagious
4. He is hard of hearing and sometimes retreats into his own private world. This affects his leadership potential, and in fact, all of his communications.

DATE April 1, 1965

SIGNATURE

Joseph L. Hoffman, Jr.

CODE

1. Personal Qualities
2. Religious Life

3. Professional Life
4. Special Problems

000165

PROVINCE OF THE PACIFIC
Office of Instruction

Rev. Brother B. Plimann Stationed at St. Joseph's Hill

1. How much time do you devote per week to the immediate preparation of class? 5 hrs
2. To what extent does extra-curricular employment affect your class preparation and teaching? Very injurious _____; Moderately injurious _____; Not injurious
3. How much time per week do you devote to the correction of written class work? 5 hrs
4. Do you consider your teaching up to standard? TRY MY BEST
5. How much time per week do you devote to professional reading? very little
6. How much time per week do you devote to your personal studies? _____
7. Are you with the community in the study room? YES
8. Are you with the community in recreation? YES
9. Is there any other employment you think you could fulfill more successfully than your present? _____

000166

Pleinmann
J

DATA FOR INDIVIDUAL STAFF MEMBERS

(Section J of *Evaluative Criteria*, 1950 Edition)

This form is to be filled out by each teacher, principal, supervisor, librarian, director of guidance, counselor, dean, director of health and physical education, and any other staff members who are responsible for instructional aspects of the educational program. *All evaluations in this section should be made by the individual staff member and reviewed by the principal or administrative head of the school.*

Name... Bernard Thomas Pleinmann School... Junipero Serra High School

Position... Math. Instructor If part-time, indicate fraction of full-time given to this secondary school.....

Subject taught... Mathematics Date.....

WEEKLY SCHEDULE

Indicate, in space below, classes and activities regularly assigned or carried out in each period (include such activities as homeroom, lunch, study hall, supervision, library, clubs, and conferences).

| Time of Period | Room Number | Monday | Tuesday | Wednesday | Thursday | Friday | Saturday |
|----------------|-------------|------------------|-------------------|-----------|------------|--------|----------|
| I | 111 | Algebra I | | | | | |
| II | 205 | Geometry | | | | | |
| III | 4-A | Trigonometry | | | | | |
| IV | | Lunch | | | | | |
| VI | 204 | Geometry | | | | | |
| VII | 3-A | Advanced Algebra | | | | | |
| VIII | | Math Coun. | Analytic Geometry | | | | |
| | | | | | PHOTO CLUB | | |
| | | | | | | | |
| | | | | | | | |

COOPERATIVE STUDY OF SECONDARY-SCHOOL STANDARDS

Copyright 1950 by Cooperative Study of Secondary-School Standards, Washington 6, D. C.

000167

Instructions

GENERAL

When the various features included in this section are being checked and evaluated, Section B, "Pupil Population and School Community," and Section C, "Educational Needs of Youth," should be kept in mind. The information revealed by these sections should be applied to every activity in the school. Persons making evaluations should ask: "How well do the practices in this school meet the needs of the pupil population and school community?" When evaluations are made, factors such as size, type, location of school, financial support available, and state requirements should not be permitted to justify failure to provide an appropriate program and facilities to meet the needs of the pupils and community served by the school. The twofold nature of the work—evaluation and stimulation to improvement—should also be kept in mind. Careful, discriminating judgment is essential if these purposes are to be served satisfactorily.

CHECKLISTS

The checklists consist of provisions, conditions, or characteristics found in good secondary schools. All of them may not be necessary, or even applicable, in every school. A school may therefore lack some of the items listed but have other compensating features. The checklists are intended to provide the factual bases for the evaluations.

The use of the checklists requires five symbols. (1) If the provision called for in a given item of a checklist is made extensively, mark the item in the parentheses preceding it with the symbol "√√" (double check); (2) if the provision is made to some extent, mark the item with the symbol "√"; (3) if the provision or condition is made to a very limited extent, mark the item with the symbol "X"; (4) if a provision is missing but is needed, mark the item with the symbol "M"; (5) if any provision or condition is missing and is not desirable or appropriate for the school, mark such item with the symbol "N." In brief, mark items:

- √√ provision or condition is made extensively
- √ provision or condition is made to some extent
- X provision or condition is very limited
- M provision or condition is missing but needed
- N provision or condition is not desirable or does not apply

Space is provided at the end of each checklist for writing in additional items. It is desirable that the provisions or practices of the school should be described as completely as possible.

EVALUATIONS

Evaluations represent the best judgment of those making the evaluations after all evidence (including results of observation of the school and discussions with the school staff, consideration of ratings on checklist items and data presented by the school, and experience of evaluators in other schools) has been considered. *Evaluations should be made first by members of the school staff.* These evaluations will be checked by members of the visiting committee at the time the school is visited. They are to be made by means of the rating scale as defined below.

- 5.—*Excellent*; the provisions or conditions are extensive and are functioning excellently.
- 4.—*Very good*;^{*}
 - a. the provisions or conditions are extensive and are functioning well, or
 - b. the provisions or conditions are moderately extensive but are functioning excellently.
- 3.—*Good*; the provisions or conditions are moderately extensive and are functioning well.
- 2.—*Fair*;^{*}
 - a. the provisions or conditions are moderately extensive but are functioning poorly, or
 - b. the provisions or conditions are limited in extent but are functioning well.
- 1.—*Poor*; the provisions or conditions are limited in extent and are functioning poorly.
- M.—*Missing*; the provisions or conditions are missing and needed; if present, they would make a contribution to the educational needs of the youth in this community.
- N.—*Does not apply*; the provisions or conditions are missing but do not apply or are not desirable for the youth of this school or community. (Reasons for the use of this symbol should be explained in each case under *Comments*.)

* If, in making the self-evaluation, members of the school staff wish to indicate which of the alternatives given for evaluations "4" or "2" applies, they may use "4a" or "4b," "2a" or "2b."

000168

Statement of Guiding Principles

A competent staff is one of the indispensable elements of a good school. Such a staff should not be merely a collection of individually competent persons. It should be a cooperating group having common purposes and motivated by common ideals. Each member of such a staff should give evidence of awareness and understanding of educational problems and should show continuous professional growth. Before election to the staff, each member should produce evidence of adequate preparation for his particular task and possession of such personal traits as are requisite to teaching and to associating with youth. Diversity of preparation and viewpoints is desirable for a well-rounded staff, but its members should have the ability and desire to work together cheerfully, harmoniously, and efficiently for the good of the school and its pupils.

In the selection of individual staff members, attention should be given to teaching ability, personality, health, and character. Each staff member should have broad general scholarship, extensive preparation in his special field, professional competence, and reasonable social development.

I. Qualifications as a Staff Member

A. PREPARATION

1. Secondary-School Attendance

List below information concerning secondary-school attendance.

| Name of School | Town or City | State | Dates of Attendance |
|----------------------------|-------------------|-------------|---------------------|
| <u>Parcell High School</u> | <u>Cincinnati</u> | <u>Ohio</u> | <u>1931-1932</u> |
| <u>Mt. St. John</u> | <u>Dayton</u> | <u>Ohio</u> | <u>1932-1934</u> |

2. College Attendance

List below information concerning attendance at colleges, universities, normal schools, or other institutions above the secondary school.

| Name of Institution | State | Dates of Attendance | Degree Granted | Date of Degree |
|------------------------------------|-------------|---------------------|---------------------|----------------|
| <u>University of Dayton</u> | <u>Ohio</u> | <u>1934...</u> | <u>B.S. in Edu.</u> | <u>1952</u> |
| <u>University of San Francisco</u> | <u>Cal.</u> | <u>1952..Spring</u> | | |
| <u>University of Southern Cal.</u> | <u>Cal.</u> | <u>1953...</u> | | |

3. School Experience

| Position | Name of School | City or County | State | Dates | Number of Years |
|----------------------|----------------------|-----------------|---------------|----------------------------------|-----------------|
| <u>ELEM. TEACHER</u> | <u>ST. JAMES</u> | <u>SAN FRAN</u> | <u>CAL</u> | <u>1936-1937</u> | <u>1</u> |
| <u>ELEM. TEACHER</u> | <u>CATHEDRAL</u> | <u>HONOLULU</u> | <u>HAWAII</u> | <u>1940-1942</u> | <u>2</u> |
| <u>ELEM. TEACHER</u> | <u>ST LOUIS C.</u> | <u>HONOLULU</u> | <u>HAWAII</u> | <u>1937-40, 1942-45, 1946-47</u> | <u>5</u> |
| <u>ELEM. TEACHER</u> | <u>ST MARVS</u> | <u>HILLO</u> | <u>HAWAII</u> | <u>1937-1939</u> | <u>2</u> |
| <u>MATH. INST</u> | <u>ST JOSEPH</u> | <u>HILLO</u> | <u>HAWAII</u> | <u>1947-1951</u> | <u>4</u> |
| <u>MATH. INST</u> | <u>J. SERRA HIGH</u> | <u>GARDENA</u> | <u>CAL.</u> | <u>1952 - PRESENT</u> | <u>5</u> |

4. Non-School Experience

If experience is not on a full-time basis, indicate that fact and enter an approximation of full-time equivalence under "Number of years."

| Position | Organization | City or County | State | Dates | Number of Years |
|-------------------|------------------------|-----------------|-----------|----------------|-----------------|
| <u>COUNSELLOR</u> | <u>ST. JOHN'S HOME</u> | <u>BROOKLYN</u> | <u>NY</u> | <u>1945-46</u> | <u>1</u> |
| | | | | | |
| | | | | | |

Total non-school experience..... 1

000169

5. Academic Preparation

| SUBJECTS | NORMAL SCHOOL, COLLEGE, OR UNIVERSITY | |
|---|---|-----------------------------------|
| | Under-graduate (sem. hrs.) ¹ | Graduate (sem. hrs.) ¹ |
| Agriculture..... | 6 | |
| Art, Fine or Applied..... | | |
| Business Education:..... | | |
| English..... | 13 | |
| Foreign Language: <i>French</i> | 9 | |
| <i>German</i> | | |
| <i>Latin</i> | | |
| <i>Spanish</i> | 4 | |
| <i>LATIN</i> | | |
| Health and Physical Education..... | | |
| Home Economics..... | | |
| Industrial Education... <i>MANUF. PROC.</i> | 4 | |
| <i>Shop Work</i> | | |
| Library Science (General)..... | 21 | 17 |
| Mathematics..... | 3 | |
| Mechanical Drawing..... | 2 | |
| Music..... | | |
| Nursing Education..... | 13 | |
| Philosophy..... | 3 | |
| Psychology, General..... | 7 | |
| Science:..... | 6 | |
| <i>Biology</i> | | |
| <i>Chemistry</i> | | |
| <i>General Science</i> | 17 | |
| <i>Physics</i> | 3 | |
| <i>SURVEYING</i> | | |
| Social Studies:..... | 3 | |
| <i>Amer. History</i> | 3 | |
| <i>Economics</i> | | |
| <i>Geography</i> | 12 | |
| <i>Other History</i> | | |
| <i>Pol. Sci. & Gov't.</i> | | |
| <i>Sociology</i> | | |
| Speech..... | 2 | |
| Others..... | | |
| Total semester hours..... | 118 | 17 |

¹ A semester hour is the credit granted for classwork of one hour per week for approximately 18 weeks. To change quarter hours to semester hours multiply the former by two-thirds.

SUMMARY

Major Specialization _____ No. of semester hours _____
 Minor Specialization _____ No. of semester hours _____

EVALUATION

() a. How adequate is the academic preparation for the subject or subjects now being taught?

COMMENTS

6. Professional Preparation

If courses taken in education overlap any of the fields listed below, indicate the content of such courses on one of the blank lines and enter corresponding credits in the spaces opposite.

| SUBJECTS | NORMAL SCHOOL, COLLEGE, OR UNIVERSITY | |
|-------------------------------|---|-----------------------------------|
| | Under-graduate (sem. hrs.) ¹ | Graduate (sem. hrs.) ¹ |
| Curriculum..... | 2 | |
| Educational Measurements..... | 2 | |
| Educational Psychology..... | 6 | |
| Educational Statistics..... | | |
| Guidance..... | | 3 |
| History of Education..... | 2 | |
| Mental Hygiene..... | 3 | |
| Methods of Teaching..... | 5 | |
| Practice Teaching..... | 3 | |
| Principles of Education..... | 3 | |
| Pupil Activities..... | | |
| Research in Education..... | | |
| School Administration..... | 2 | |
| Supervision..... | | |
| Work Shop..... | 2 | |
| <i>and is reserved</i> | | |
| Total semester hours..... | 32 | 3 |

Give details of certificates held.

- Agency issuing certificate.....
- Type or name of certificate.....
- Subjects endorsed on certificate.....
- Administration position approved....
- Date of certification.....

EVALUATION

() a. How adequate is the professional preparation for the present assignment?

COMMENTS

B. IMPROVEMENT IN SERVICE

In general the data desired below are for the last three years, but any activity of special significance related to improvement in service should be included regardless of when the activity was carried out.

1. Membership in Professional Organizations

Indicate the name of national, state, and local professional organizations in which membership is held (e.g., National Education Association, National Council for the Social Studies, State Teachers Federation).

- a. SEISMOLOGICAL SOCIETY
- b. AMERICAN GEOPHYSICAL UNION
- c.
- d.
- e.
- f.
- g.

Discuss appearances on programs of professional educational organizations indicating topic, organization, and date of appearance.

2. Professional Reading

List below the professional educational books which have been read within the last six months and professional magazines which are read regularly.

a. Books

b. Magazines

NAT. COUNCIL MATH TEACHERS
 CATHOLIC EDUCATOR
 SEC. SCIENCE & MATH.

3. College or In-Service Courses

Indicate courses taken during the past three years or now being taken. Do not include courses taken before beginning teaching.

GUIDANCE
 VECTOR ANALYSIS
 THEORY OF NUMBERS
 APPL. MATH

000171

4. Study of School Problems

Describe participation either individually or through committees in the study of educational problems or teaching techniques and procedures. Indicate nature of study, plans involved, and outcomes which were achieved.

Participated on committee to improve the caliber of math students.
Sought way and means through testing to improve results of our students in standardized tests and in contests.

Results: in my classes the students were consistently above the national norms in Algebra, Geometry and trigonometry

5. Additional In-Service Activities

Describe below additional experiences such as extensive travel; recreational activities; visits to government centers, museums, industries, or other schools; and writing or research activities which contributed to professional improvement. Discuss the educational significance of such experiences.

EVALUATIONS

- () a. *How extensive have been the efforts to improve in service?*
() b. *How effective have been the efforts to improve in service?*

COMMENTS

000172

C. TEACHER LOAD

1. Enter in the table below the data called for with respect to each class taught.

| Name of Course | Number of Pupils Enrolled | Number of Periods per Week | Minutes per Day Spent in Additional Teaching Duties* |
|--------------------|---------------------------|----------------------------|--|
| Elementary Algebra | 45 | 5 | 20 |
| Geometry | 85 | 10 | 40 |
| Trigonometry | 30 | 5 | 15 |
| Advanced Algebra | 36 | 5 | 20 |
| Analytic Geometry | 10 | 3 | 10 |
| | | | |
| | | | |
| Total..... | 206 | 28 | 105 |
| Average..... | 34 ** | 6 *** | 1 hr 45min** |

* Include time spent in planning and preparing for classes, developing instructional materials, correcting papers and examinations, and similar activities.

** Divide total above by number of classes to obtain average class size.

*** Divide total above by 5 to obtain average number of periods per day.

**** Divide total above by 60 to obtain average number of hours, or fractional part thereof, per day spent in additional teaching duties.

2. What is the length of a typical class period including time for change of classes? _____ minutes.
3. List below the regularly assigned duties other than classroom instruction. Indicate the average number of hours spent *per week*. Include such activities as study hall, library, pupil activity program, administrative duties, supervision, guidance, conferences, committee work, and research activities. Indicate if any of these duties are seasonal (e.g., coaching hockey, spring music festival, graduation exercises).

| Nature of Activity | Hours per Week | Weeks per Year |
|--------------------|----------------|----------------|
| Photography Club | 1 hr | 36 |
| Math Counselling | 2 hrs. | 36 |
| | | |
| | | |
| | | |
| | | |

EVALUATION

() a. How satisfactory is the teacher load?

COMMENTS

000173

D. PROFESSIONAL QUALIFICATIONS

The following checklist and evaluation items are applicable only to members of the instructional staff. All of these items should be checked and evaluated by the individual teacher and reviewed by the administrative head of the school.

CHECKLIST

This teacher as a professional worker

- | | |
|--|--|
| <input type="checkbox"/> 1. Shows evidence of understanding the contribution of his area of teaching to the educational needs of pupils. | <input type="checkbox"/> 10. Adapts instruction to the needs of individual pupils. |
| <input type="checkbox"/> 2. Shows a willingness to cooperate with other teachers in meeting the educational needs of pupils. | <input type="checkbox"/> 11. Makes effective use of supplementary aids (e.g., audio-visual aids). |
| <input type="checkbox"/> 3. Shows evidence of planning carefully for instructional activities. | <input type="checkbox"/> 12. Makes effective use of community resources (e.g., industries, museums, parks, school grounds, local history, members of community). |
| <input type="checkbox"/> 4. Willingly changes plans and procedures in instructional activities when conditions suggest such changes (e.g., different philosophy of classification of pupils, community needs or activities, out-of-school activities of pupils). | <input type="checkbox"/> 13. Provides opportunities for pupils to participate in both individual and group activities. |
| <input type="checkbox"/> 5. Provides flexibility in adapting instructional activities to new or changing conditions which develop within the classroom. | <input type="checkbox"/> 14. Conducts procedures in assignments, examinations, and evaluations of pupil achievement in such a manner as to encourage individual integrity on the part of pupils. |
| <input type="checkbox"/> 6. Provides opportunities for pupils to participate in <i>planning</i> instructional activities. | <input type="checkbox"/> 15. Keeps accurate records of pupil achievement. |
| <input type="checkbox"/> 7. Provides opportunities for pupils to participate in <i>conducting</i> instructional activities. | <input type="checkbox"/> 16. Participates in the in-service training program of the staff. |
| <input type="checkbox"/> 8. Provides opportunities for pupils to participate in <i>evaluating</i> the results of instructional activities. | <input type="checkbox"/> 17. Assists in establishing cooperative relationships with parents and other members of the community. |
| <input type="checkbox"/> 9. Gives evidence of increasing interest and skill in studying growth and development of individual pupils. | <input type="checkbox"/> 18. |
| | <input type="checkbox"/> 19. |

EVALUATIONS

- a. How effectively are plans and preparations made for instructional activities?
- b. To what extent are instructional activities conducted democratically?
- c. How skillfully are instructional activities carried out?
- d. How satisfactory are relationships with school associates?
- e. How satisfactory are relationships with members of the community?
- f. How satisfactory is the attitude toward teaching as a profession?

COMMENTS

E. SPECIAL COMMITTEE JUDGMENT

This evaluation is to be made by the visiting committee after actual classroom visitation.

EVALUATION

- a. How satisfactorily is the instructional work carried on by this teacher?

COMMENTS

INTRODUCTION

We are going to study something about systems of numbers. You have learned to some extent how to use one system. Did you know that there are a great many possible systems? You may think of Roman Numerals. This is not another system. It is a different way of writing or as we say, different notations. Other systems will be developed in this course. We will also try to understand how you were taught arithmetic and why you were taught it in that particular way.

SYMBOLS:

The symbols we use are arbitrary. We could have agreed to an entirely different type, such as: $\bar{1}$, $\bar{2}$, $\bar{3}$, $\bar{4}$, ... for our 1, 2, 3, 4, ...

For instance the Greeks use their alphabet as numbers.
 α (alpha) = 1, β (beta) = 2, γ (gamma) = 3, δ (delta) = 4... etc.

Or, the Roman Numerals; I, II, III, IV, ...

Or, the Chinese characters: 一, 二, 三, 四 ... for 1, 2, 3, 4...

Egyptians, Assyrians, Hebrews, etc. all had their own symbols. Computing, as we do with ours, would be much more difficult with the others. Most of these people used some kind of abacus for their Arithmetical computations. An ABACUS is some kind of board or tray with counters that can be manipulated to add, subtract, etc. The abacus was used in Europe extensively until 1500 when our present rules in computing won supremacy. In Europe by the eighteenth century the use of the abacus had disappeared. These simple instruments are still widely used in China and Japan.

ONE NUMBER SYSTEM:

Our number system is based on ten symbols: 0, 1, 2, 3, 4, 5, 6, 7, 8, 9. With these we can write any number however large. This makes it far superior to all other methods of notations. This can easily be proved by illustrating. Let us see how others would write 234.

Roman: CCXXXIV

Greek: $\kappa\alpha\beta$ (read: kappa pi delta)

Chinese: 二三四

(1)

(2)

(3)

000175

In Roman numerals the values of the various symbols are added together. In the above example: 100 + 100 + 50 + 10 + 10 + 4 = 284.

In the Grecian method k (kappa) means 200, π is 80 and δ is 4, thus, they get 284. This system is easier and fewer numbers to write than the Romans. However, it is not as efficient as the Hindu-Arabic as it needs many more symbols.

Chinese write in columns. Each character stands for a word and the number is read. In our example: 百 (hundred), 八 (eight), 十 (ten), 四 (four)

In our system a different interpretation of the symbol depends on its position in the number. The 2 in 284 stands 200, the 8 for 80, and the 4 for 4. In grammar school the position of the 4 is called units, the 8, tens, and the 2 hundreds. The next places would be called thousands, hundreds of thousands, millions, etc.

PROJECT: try to find as many of the Roman, Grecian and Chinese symbols as you can. Try to learn how to write numbers and how to transfer them to the Hindu-Arabic system.

ADDITION

Do you remember how you learned addition? Most of us started with our fingers. Whenever we could not remember the name of a number we would hold up the number of fingers the number we wanted represented. As we learned the basic words for the symbols we used our fingers less and less. As we learned to count we learned to add:

2 + 3 = 5 // + /// = /////

A difficulty might have arose when we ran out of fingers

7 + 6 = 13 //

This would be 2 set of hands and three more or

10 + 3 = 13

000176

From here we could proceed along these lines and form an addition table:

| | | | | | | | | | | |
|---|---|----|----|----|----|----|----|----|----|----|
| | 0 | 1 | 2 | 3 | 4 | 5 | 6 | 7 | 8 | 9 |
| 0 | 0 | 1 | 2 | 3 | 4 | 5 | 6 | 7 | 8 | 9 |
| 1 | 1 | 2 | 3 | 4 | 5 | 6 | 7 | 8 | 9 | 10 |
| 2 | 2 | 3 | 4 | 5 | 6 | 7 | 8 | 9 | 10 | 11 |
| 3 | 3 | 4 | 5 | 6 | 7 | 8 | 9 | 10 | 11 | 12 |
| 4 | 4 | 5 | 6 | 7 | 8 | 9 | 10 | 11 | 12 | 13 |
| 5 | 5 | 6 | 7 | 8 | 9 | 10 | 11 | 12 | 13 | 14 |
| 6 | 6 | 7 | 8 | 9 | 10 | 11 | 12 | 13 | 14 | 15 |
| 7 | 7 | 8 | 9 | 10 | 11 | 12 | 13 | 14 | 15 | 16 |
| 8 | 8 | 9 | 10 | 11 | 12 | 13 | 14 | 15 | 16 | 17 |
| 9 | 9 | 10 | 11 | 12 | 13 | 14 | 15 | 16 | 17 | 18 |

In your primary grades you were drilled and drilled on these tables until the answers came automatically. You were then ready to extend this knowledge to larger numbers.

if, $8 + 6 = 14$, then, $18 + 6 = 24$, and
 if $5 + 7 = 12$, then, $45 + 7 = 52$.

The tens digit changes 1 in $8 + 6$ and in $5 + 7$, thus, it must change one in $18 + 6$ and in $45 + 7$. Absorbing these ideas you easily moved on to single columns. Then upon learning the rule of "carrying" you proceeded without too much trouble to the addition of several columns. Let's observe the following example:

$$\begin{array}{r} 635 \\ 424 \\ 558 \\ \hline 146 \end{array}$$

Adding the units column gives you 23. The 3 is put in the units column and the 2 which is a tens is carried to the next column, the tens. By adding 2 to the tens column we are in reality adding 20. Adding the tens we get 16 (actually 160). We put the 6 in the tens position and carry 1 to the hundreds column. What are we really adding when the 1 is carried? Do you see that by carrying the 1 to the hundreds we are adding 100? Adding the last column you get 17. Thus, the answer to this addition is 1763.

000177

SUBTRACTION

Subtraction is the inverse of addition. One who knows the addition table should have little trouble in solving simple subtraction problems. To subtract 5 from 8, you ask yourself what number added to 5 will give you 8 ..., thus, 3.

Many students have trouble with "borrowing". Let's use "436 - 148" as an example and illustrate "borrowing" by showing all the work.

$$\begin{array}{r} 34\overset{12}{\cancel{3}}6 \\ - 148 \\ \hline 288 \end{array}$$

You could start this problem by saying 8 from 6, 6 is too small so borrow 1 from 3 making it 2 and adding it to the 6 making it 16. Then, 8 from 16 is 8. 4 from 2, and then by "borrowing" we get 4 from 12 is 8. Then, 1 from 3 is 2. Answer is 288. There are many things in the above method that often bothers thinking students. They would inquire... if I add 1 to 6 would I not get 7 instead of 16? How can this be clarified? We must go back to our number system...the 1 we are taking is in the tens column and is then actually a 10 and adding it to 6, we do get 16. Similarly, borrowing the 1 off of the 4 in the hundreds column you are borrowing 100 and adding it to the 2, which is really 20, you get 120.

Perhaps, by writing the numbers as sums you will understand the "borrowing" method a little better. Using the above problem as an example:

$$\begin{array}{r} 436 \\ - 148 \\ \hline \end{array} \quad \begin{array}{l} 400 + 30 + 6 \\ 100 + 40 + 8 \end{array} \quad \text{is changed to} \quad \begin{array}{r} 300 + 120 + 16 \\ 100 + 40 + 8 \\ \hline 200 + 80 + 8 \end{array}$$

EXERCISE: Subtract by writing the numbers as sums:

$$\begin{array}{r} 345 \\ - 141 \\ \hline \end{array} \quad \begin{array}{r} 182 \\ - 142 \\ \hline \end{array} \quad \begin{array}{r} 536 \\ - 379 \\ \hline \end{array} \quad \begin{array}{r} 1457 \\ - 567 \\ \hline \end{array} \quad \begin{array}{r} 3106 \\ - 2453 \\ \hline \end{array}$$

MULTIPLICATION

Multiplication is a shorten form of addition. This new operation was developed to facilitate the laborous work of adding long columns of the same number. A simple problem like the following would be long and tedious: " Mary lives 13 miles from town, Jehn lives 12 times as far from this town. How far does John live from it?" without multiplication we would have to put twelve 13 in a column and then add. Think of the job it would be to find the distance the sun is from the earth, if we knew it was 390 times as far as the moon which is 240,000 miles away!

Avoiding the long addition columns the same number is possible by the multiplication table. Originally the table was made by adding the same number together the required number of times or simply "counting " by that number.

Thus, for 4×7

$$\begin{array}{r} 7 \\ 7 \\ 7 \\ 7 \\ \hline 28 \end{array}$$

In the space below, neatly fill out the table.

| | 0 | 1 | 2 | 3 | 4 | 5 | 6 | 7 | 8 | 9 |
|---|---|---|---|---|---|---|---|---|---|---|
| 1 | | | | | | | | | | |
| 2 | | | | | | | | | | |
| 3 | | | | | | | | | | |
| 4 | | | | | | | | | | |
| 5 | | | | | | | | | | |
| 6 | | | | | | | | | | |
| 7 | | | | | | | | | | |
| 8 | | | | | | | | | | |
| 9 | | | | | | | | | | |

000179

Usually in the third or fourth grade you learned these tables as far as the 12s. This was not really necessary. If you knew from 1 to 9 you could handle any number. For example: 8×426 . Since 6×8 is 48, we put the 8 in the units place and hold the 4 for the tens. Then, $8 \times 2 = 16$ and the 4 is 20, we put the 0 in the tens place and hold the 2 for the hundreds. Finally, $8 \times 4 + 2 = 34$. Thus, the answer is 3408. Or putting it a little differently, it would be done as follows:

$$(8 \times 6) + (8 \times 20) + (8 \times 400) = 48 + 160 + 3200 = 3408$$

To go on to any multiplication presents little difficulty. Take for example, 426×138

$$\begin{array}{r} 426 \\ 138 \\ \hline 3408 \\ 12780 \\ 42600 \\ \hline 58788 \end{array}$$

The Eight multiplies as in the previous example. The 3 in our multiplier, 138, is in the tens place so it is really 30. The product is 12780. The 1 in the hundreds place is a 100. $100 \times 426 = 42600$ and the sum of these products is the answer, 58788. Usually the zeros at the end of the number are dropped for simplicity.

DIVISION

Division is the inverse of multiplication. It is a shorten form of subtraction. Many can see how multiplication is a shorten form of addition but few have had it explained how division is a quicken subtraction. If you want to divide 56 by 7 you were told to ask yourself what number multiplied by 7 gives 56 ... obviously from the multiplication table 8.

Suppose you wanted to divide 258 by 72 using subtraction.

$$\begin{array}{r} 258 \\ - 72 \\ \hline 186 \end{array} \quad (1) \quad \begin{array}{r} 186 \\ - 72 \\ \hline 114 \end{array} \quad (2) \quad \begin{array}{r} 114 \\ - 72 \\ \hline 42 \end{array} \quad (3)$$

Since we were able to subtract 72 three complete times, the answer of " $258 \div 72$ " is 3 and a remainder of 42.

If the divisor has more than one digit we called this long division, for example, $14950 \div 46$

$$\begin{array}{r} 325 \\ 46 \overline{)14950} \\ \underline{138} \\ 115 \\ \underline{92} \\ 230 \\ \underline{230} \\ 0 \end{array}$$

The above method is familiar to all who have studied Arithmetic. Let's do the problem by repeated subtraction and compare this to the method we have learned in our elementary schools.

$$\begin{array}{r} 14950 \\ - 4600 \quad (46 \times 100) \\ \hline 10350 \\ - 4600 \quad (46 \times 100) \\ \hline 5740 \\ - 4600 \quad (46 \times 100) \\ \hline 1150 \\ - 460 \quad (46 \times 10) \\ \hline 690 \\ - 460 \quad (46 \times 10) \\ \hline 230 \\ - 46 \quad (46 \times 1) \\ \hline 184 \\ - 46 \quad (46 \times 1) \\ \hline 138 \\ - 46 \quad (46 \times 1) \\ \hline 92 \\ - 46 \quad (46 \times 1) \\ \hline 46 \\ - 46 \quad (46 \times 1) \\ \hline 0 \end{array}$$

Thus, it can be seen that we had to take three (46×100), then two (46×10) and finally, five (46×1) or we had to take 325×46 to get 14950. In other words, $14950 \div 46 = 325$.

NOTE The method that the Calculator uses to solve division is by this repeated subtraction method. Multiplication is done by repeated addition. If it is possible get a demonstration of how to multiply and divide on a Calculator.

Problems: Divide 63452 by 396. (a) first by the usual long division method. (b) try to do it by repeated subtraction. (c) try to see the relation between "long division and repeated subtraction.

000181

DECIMAL SYSTEM

Before proceeding let us try to understand our number system a little better. It is called decimal because it is based on ten or powers of ten. Take the number 3487. From what we have learned about the position of numbers, the 3 stands for 3000, the 4 for 400, the 8 for 80 and the 7 for 7.

thus, $300 + 400 + 80 + 7 = 3487$
Now, since $10^3 = 1000$, $10^2 = 100$, $10^1 = 10$ and $10^0 = 1$
I can rewrite the above number as a power of 10

$$3(10)^3 + 4(10)^2 + 8(10)^1 + 7(10)^0$$

We now have the number 3487 written to the power of our base, 10.

To write a number that is in decimal notation to the power of ten requires a knowledge of negative exponents. The following values will be given as true.

$$10^{-1} = \frac{1}{10} \text{ or } .1$$

$$10^{-2} = \frac{1}{100} \text{ or } .01$$

$$10^{-3} = \frac{1}{1000} \text{ or } .001$$

$$10^{-4} = \frac{1}{10000} \text{ or } .0001$$

The above values need to be known in order to write a number that is a decimal. Using 32.586 as an example. We will first write it as a sum of whole numbers and fractions.

$$= 30 + 2 + \frac{5}{10} + \frac{8}{100} + \frac{6}{1000}$$

then, as a sum of the powers of ten,

$$3(10)^1 + 2(10)^0 + 5(10)^{-1} + 8(10)^{-2} + 6(10)^{-3}$$

It should be noted that it is written in successive descending powers of ten. Always have the power of ten in succession even when there are zeros in the number. Writing 60.03 as a power of 10.

$$6(10)^1 + 0(10)^0 + 0(10)^{-1} + 3(10)^{-2}$$

EXERCISE: Write the following numbers as powers of 10.

- | | |
|---------|-------------|
| 1) 314 | 4) 3.632 |
| 2) 1405 | 5) 7.024 |
| 3) 5006 | 6) 3000.005 |

NUMBER SYSTEMS AND NUMBER BASES:

Our number system to the base 10 need not be the only system. Any number may be used as a base. As mentioned previously the base "10" came into use because of the correspondance with the digits on our hands. If we fully understand the decimal number system it is somewhat easy to deal with numbers of other bases. We are going to select a different base and follow a procedure of developing this system similar to the one given beginning on page 1. Later you are going to be assigned a number and you will have to use a similar process to develop a system with that number as base.

Let's chose the number "8" as the base of our new number system. We can even give this system a name. Let's call it the "octary" system.

OCTARY SYSTEM

This system has eight symbols: 0, 1, 2, 3, 4, 5, 6, and 7. With these eight symbols we can represent any amount, however large.

Changing a decimal number to "Octary"

If we want to represent a number in the "octary" system we have to write this number as a power of "8". Let's use 428 to illustrate the method. Since we have to represent 428 as the sum of the powers of 8 we calculate the value of some powers of 8.

$$8^0 = 1 \quad 8^1 = 8 \quad 8^2 = 64 \quad 8^3 = \overset{512}{\cancel{872}}$$

Method: 8^3 is too large. We take 8^2 or 64 and see how many times it is contained into 428... 6 and a remainder of 44.

8^1 or 8 is contained into 44 ... 5 and a remainder of 4

8^0 or 1 is contained into 4... 4

Thus, we can write 428 as the sum of the powers of **000183**

$$6(8)^2 + 5(8)^1 + 4(8)^0$$

or, 428 in the decimal system is equivalent to 654 in the "octary" system. We usually represent this as:

$$(428)_{10} = (654)_8$$

Working out another example should help to clarify things.

$$(705)_{10} = (?)_8$$

| | | |
|--|--------------------------------------|------------------------------------|
| 8^3 or 672 ⁵¹² | is contained into 705 ... | 1 and a remainder of 93 |
| 8^2 or 64 | is contained into 193 ... | 9 and a remainder of 1 |
| 8^1 or 8 | is contained into 11 ... | 0 and a remainder of 1 |
| 8^0 or 1 | is contained into 1... | 1 |

thus, $(705)_{10} = (\overset{1301}{\del{193}})_8$ since,

$$1(8)^3 + 9(8)^2 + 0(8)^1 + 1(8)^0 = 705$$

Note that they are written in the descending powers of 8 the same way that we wrote the numbers as the descending powers of 10.

Changing an "octary" number to a decimal:

If you understand what a number written to the base is this will be rather simple. Let us illustrate with the octary number 4203.

$$(4203)_8 = (?)_{10}$$

Simply write this as a power of "8"

$$4(8)^3 + 2(8)^2 + 0(8)^1 + 3(8)^0 = 2688 + 128 + 0 + 3 = 2819$$

$$\text{or, } (4203)_8 = (2819)_{10}$$

EXERCISE:

1. Change the following decimal numbers to "octary"

a. 324 b. 442 c. 1234 d. 3121 e. 4004

2. Change the following "octary" to decimal

a. $(424)_8$ b. $(607)_8$ c. $(3242)_8$ d. $(1234)_8$ e. $(3041)_8$

3. Match the first hundred numbers in the "octary" system with those of the decimal. (Do this neatly and save as it will be useful in the coming exercises.)

ADDITION

To do in this "octary" system we will have to form an addition tables with the base 8 using only our symbols from 0 to 7. The third problem in the above exercise will greatly aid us. We can get it by "counting" by each number.

| | 0 | 1 | 2 | 3 | 4 | 5 | 6 | 7 |
|---|---|----|----|----|----|----|----|----|
| 0 | 0 | 1 | 2 | 3 | 4 | 5 | 6 | 7 |
| 1 | 1 | 2 | 3 | 4 | 5 | 6 | 7 | 10 |
| 2 | 2 | 3 | 4 | 5 | 6 | 7 | 10 | 11 |
| 3 | 3 | 4 | 5 | 6 | 7 | 10 | 11 | 12 |
| 4 | 4 | 5 | 6 | 7 | 10 | 11 | 12 | 13 |
| 5 | 5 | 6 | 7 | 10 | 11 | 12 | 13 | 14 |
| 6 | 6 | 7 | 10 | 11 | 12 | 13 | 14 | 15 |
| 7 | 7 | 10 | 11 | 12 | 13 | 14 | 15 | 16 |

It will be unnecessary to memorize the above table.

This is to serve as a guide for addition and subtraction with "Octary" numbers.

Taking a simple problem such as: $4 + 2 + 6 + 4 + 7$
 We proceed using the table: $4 + 2 = 6$, $6 + 6 = 14$,
 $14 + 4 = 20$ ($4 + 4$ is 10...put down the 0 and carry 1)
 $20 + 7 = 27$. This answer is read as: two seven.

Here is a little harder one:

$$\begin{array}{r} 423 \\ 215 \\ 624 \\ \hline 321 \end{array}$$

$1 + 4 = 5$, $5 + 5 = 12$, $12 + 3 = 15$. Put down the 5 and carry 1.
 $1 + 7 = 10$, $10 + 2 = 12$, $12 + 1 = 13$, $13 + 2 = 15$. 5 and carry 1.
 $1 + 3 = 4$, $4 + 6 = 12$, $12 + 2 = 14$, $14 + 4 = 20$

Thus the answer is: 2055

000185

EXERCISE:

| | | | | |
|---|--|---|--|--|
| 1) $\begin{array}{r} 3 \\ 5 \\ 6 \\ 4 \\ \underline{2} \end{array}$ | 2) $\begin{array}{r} 12 \\ 35 \\ 48 \\ 72 \\ \underline{11} \end{array}$ | 3) $\begin{array}{r} 426 \\ 121 \\ 725 \\ 662 \\ \underline{444} \end{array}$ | 4) $\begin{array}{r} 3214 \\ 1464 \\ 7653 \\ 2204 \\ \underline{7635} \end{array}$ | 5) $\begin{array}{r} 1416 \\ 3345 \\ 1707 \\ 2211 \\ \underline{5664} \end{array}$ |
|---|--|---|--|--|

SUBTRACTION:

Since subtraction is the inverse of addition we can use our addition table to solve subtraction.

To subtract 6 from 12 you must ask yourself what number added to 6 will give you 12. We can readily do this on the table. Find 6 in the vertical column, move horizontally to the right until 12 which is found in the "4" column.

Thus, $12 - 6 = 4$.

or trying 3 from 11 ... Did you get 6?

Subtracting larger number will necessitate "borrowing". Borrowing in the "octary" system is done in the same manner as it is done in the decimal.

Let's solve, $456 - 147$.

$$\begin{array}{r} 3 \cancel{4} 12 \\ \underline{147} \\ 267 \end{array}$$

METHOD: Since 6 is too small, "borrow" making it $16 - 7 = 9$. The 3 has become a 2, and is too small. Borrowing we get $12 - 4 = 8$. Then, $3 - 1 = 2$. Thus the answer is 267.

EXERCISE:

| | | | | | |
|---|--|--|--|--|--|
| 1) $\begin{array}{r} 13 \\ \underline{= 4} \end{array}$ | 2) $\begin{array}{r} 26 \\ \underline{- 17} \end{array}$ | 3) $\begin{array}{r} 342 \\ \underline{- 115} \end{array}$ | 4) $\begin{array}{r} 456 \\ \underline{- 373} \end{array}$ | 5) $\begin{array}{r} 4260 \\ \underline{- 1563} \end{array}$ | 6) $\begin{array}{r} 6027 \\ \underline{- 1454} \end{array}$ |
|---|--|--|--|--|--|

| | | | |
|--|--|--|---|
| 7) $\begin{array}{r} 5500 \\ \underline{- 3243} \end{array}$ | 8) $\begin{array}{r} 30103 \\ \underline{- 24565} \end{array}$ | 9) $\begin{array}{r} 73712 \\ \underline{- 10777} \end{array}$ | 10) $\begin{array}{r} 30022 \\ \underline{- 12377} \end{array}$ |
|--|--|--|---|

11) $(324)_8 = ()_{10}$ 12) $()_8 = (349)_{10}$

MULTIPLICATION

We must now develop a multiplication table. Since the process of multiplying is a shorten form of addition we can use our addition table to compute the Multiplication Table.

Developing the entire table is going to be left to the student as an exercise. Multiplication by 2's can be done by counting by 2's.

Thus, 0, 2, 4, 6, 10, 12, 14, 16, 20,

or the 5's by counting by 5's,

0, 5, 12, 17, 24, 31, 36, 43,

Now, complete the table below:

| | 0 | 1 | 2 | 3 | 4 | 5 | 6 | 7 |
|---|---|---|----|----|----|----|----|----|
| 1 | 0 | 1 | 2 | 3 | 4 | 5 | 6 | 7 |
| 2 | 0 | 2 | 4 | 6 | 10 | 12 | 14 | 16 |
| 3 | 0 | 3 | 6 | 11 | 14 | 17 | 22 | 25 |
| 4 | 0 | 4 | 10 | 14 | 20 | 24 | 30 | 34 |
| 5 | 0 | 5 | 12 | 17 | 24 | 31 | 36 | 43 |
| 6 | 0 | 6 | 14 | 22 | 30 | 36 | 44 | 54 |
| 7 | 0 | 7 | 16 | 25 | 34 | 43 | 52 | 61 |

There will be no need to memorize this table. Refer to it as often as you need. It will be used for division.

METHOD:

The method of "carrying" etc. that you learned in the decimal will be similar to the way we will use in the "Octary" system.

For example, 5×426

$$\begin{array}{r}
 426 \\
 \times 5 \\
 \hline
 2130
 \end{array}$$

$5 \times 6 = 36$, put down the 6 and hold the 3 for the next place. Then, $5 \times 2 + 3 = 13$. Put down the 3 and carry the 1. Finally, $5 \times 4 + 1 = 21$. Thus, the answer is 2130.

Proceeding to any multiplication should now present little difficulty. Let's solve, 426×125 with octary numbers.

$$\begin{array}{r}
 426 \\
 \times 125 \\
 \hline
 2130 \\
 10500 \\
 \hline
 53115
 \end{array}$$

The 5 multiplies as in the previous example. The 2 is actually a 20. $20 \times 426 = 10500$. The 1 in 125 is a 100. Thus, $100 \times 426 = 42600$. The addition of these products is the answer, 53115.

EXERCISE: multiply the following "octary" numbers.

1) $\begin{array}{r} 25 \\ \times 3 \\ \hline \end{array}$ $\begin{array}{r} 16 \\ \times 4 \\ \hline \end{array}$ $\begin{array}{r} 146 \\ \times 31 \\ \hline \end{array}$ $\begin{array}{r} 161 \\ \times 4 \\ \hline \end{array}$ $\begin{array}{r} 456 \\ \times 112 \\ \hline \end{array}$ $\begin{array}{r} 1432 \\ \times 112 \\ \hline \end{array}$

2) $\begin{array}{r} 4560 \\ \times 31 \\ \hline \end{array}$ $\begin{array}{r} 1415 \\ \times 31 \\ \hline \end{array}$ $\begin{array}{r} 1703 \\ \times 212 \\ \hline \end{array}$ $\begin{array}{r} 6287 \\ \times 1111 \\ \hline \end{array}$ $\begin{array}{r} 1037 \\ \times 1001 \\ \hline \end{array}$

3) In the above problems imagine each problem in (1) in the decimal system and check your decimal answer with your octary solution.

4) Can you find the digit 7? Answer: 49 is a number 73 in base 8.

5) Solve $1141_7 = (\quad)_{10}$

000188

DIVISION

Division is the inverse of multiplication. In the "octary" system as in the decimal, if you want to divide say 36 by 5, you must ask yourself what number multiplied by 5 will be 36. The answer can be found by consulting your multiplication table. There we can see that $5 \times 6 = 36$. Thus, $36 \div 5 = 6$.

Let's solve one a little more difficult, for example,

$$432 \div 6$$

$$\begin{array}{r} 6 \overline{) 432} \\ \underline{57} \\ 57 \\ \underline{57} \\ 0 \end{array}$$

METHOD: first you think what number times 6 is close to 43... $6 \times 5 = 36$. Thus, 6 goes into 43 5 times and a remainder of 5. The remainder of 5 is put along side the next number 2. Then, $52 \div 6 = 7$. The answer is 57.

This can easily be proved by multiplication.

$$\begin{array}{r} 57 \\ \times 6 \\ \hline 432 \end{array}$$

Let's try one with more than one digit in the divisor.

$$\text{For example: } 17570 \div 46$$

$$\begin{array}{r} 324 \\ 46 \overline{) 17570} \\ \underline{162} \\ 137 \\ \underline{114} \\ 230 \\ \underline{230} \\ 0 \end{array}$$

METHOD: Trial dividing.. 4 into 17 goes about 3. Putting the 3 over the 5 you multiply 3 by 46 giving 162. Subtract 162 from 175 is 13. Bringing down the 7 and trial dividing 4 into 13 gives us 2. Multiplying 2 by 46 is 114. $137 - 114 = 23$. When the 00 is brought down we have 230. $23 \div 4 = 6$. Then $4 \times 46 = 230$. Subtracting there will be no remainder. Thus, $17570 \div 46 = 326$.

It would be interesting to solve this problem by repeated subtraction. Refer to the section on page 7 and try to solve this using the octary system.

Here is how you start:

$$\begin{array}{r}
 17570 \\
 - 4600 \quad (46 \times 100) \\
 \hline
 12770 \\
 - 4600 \\
 \hline
 6170 \\
 - 4600 \\
 \hline
 1370 \\
 - 460 \quad (46 \times 10) \\
 \hline
 710 \\
 \text{etc.}
 \end{array}$$

If there are remainders it can be written as a fraction in the same manner that was done in the decimal. In the next section there will be more on fractions.

EXERCISE: Divide the following. Prove by multiplication.

- | | |
|-------------|----------------|
| 1) 453 ÷ 4 | 5) 5532 ÷ 12 |
| 2) 3104 ÷ 6 | 6) 2206 ÷ 32 |
| 3) 1014 ÷ 7 | 7) 41044 ÷ 724 |
| 4) 5523 ÷ 3 | 8) 23230 ÷ 427 |

FRACTIONS: These may be defined as parts of the whole.

They represent a division. The upper number called the numerator is the dividend and the lower number called the denominator is the divisor.

We can have fractions in the octary system. The rules that you learned in Arithmetic will be the same if you have to use octary numbers.

First, let us see how to change from one system to another. Here are some examples. From these see if you can devise the method

$$\left(\frac{3}{8}\right)_{10} = \left(\frac{3}{10}\right)_8 \quad \text{and} \quad \left(\frac{5}{12}\right)_{10} = \left(\frac{5}{14}\right)_8$$

Did you notice that you simply have to change each number to the other system?

Octary numbers can be reduced...

$$\frac{6}{34} = \frac{3}{16}$$

Checkings $\left(\frac{6}{34}\right)_8 = \left(\frac{6}{28}\right)$ or $\frac{3}{14}$ $\left(\frac{3}{14}\right)_{10} = \left(\frac{3}{16}\right)_8$

000190

Mixed Numbers can be changed to Improper Fractions in the Octary System the same manner that is done in the Decimal.

$$3\frac{2}{3} = \frac{13}{3} \quad \text{or} \quad 12\frac{3}{16} = \frac{217}{16}$$

Let's check the second example by changing the example and the answer as an improper fraction to the Decimal System.

$$(12\frac{3}{16})_8 = (10\frac{3}{14})_{10} = (\frac{143}{14})_{10}$$

$$(\frac{217}{16})_8 = (\frac{143}{14})_{10}$$

Exercise:

1) If possible reduce the following octary fractions:

$$\frac{4}{22}, \frac{3}{11}, \frac{6}{24}, \frac{3}{36}, \frac{3}{21}, \frac{7}{61}, \frac{7}{42}, \frac{21}{24}, \frac{32}{64}$$

2) Change the following to Improper Fractions:

$$3\frac{5}{7}, 4\frac{2}{3}, 5\frac{3}{5}, 6\frac{7}{10}, 4\frac{3}{21}, 21\frac{5}{10}$$

3) Change the following to mixed numbers:

$$\frac{21}{4}, \frac{61}{12}, \frac{14}{3}, \frac{52}{17}, \frac{21}{6}, \frac{32}{4}, \frac{48}{9}$$

Other operations of fractions in the Octary System follow procedures similar to the ones used in elementary Arithmetic.

ADDITION:

$$3\frac{3}{4}$$

$$5\frac{5}{12}$$

$$6\frac{1}{10}$$

000131

First we must find the least common multiple to 4, 10 and 12. We discover it to be 60. We then change each fraction to a denominator of 60.

$$\frac{3}{4} = \frac{45}{60}, \quad \frac{5}{12} = \frac{25}{60}, \quad \frac{1}{10} = \frac{6}{60}$$

Adding the numerators, 45, 25 and 6 we get 76. Thus the sum of the fractional part is $\frac{76}{60}$ or $1\frac{16}{60}$ or reduced to $1\frac{4}{15}$

Carrying the 1 and adding the whole number part we get the complete answer $17\frac{4}{15}$.

We can check this by changing the example to decimal numbers solving it and then changing to the octary. This would

be: $3 \frac{3}{4} + 5 \frac{1}{2} + 6 \frac{1}{8} \times 15^{\frac{1}{8}} = 15 \frac{3}{8}$
 $(15 \frac{3}{8})_{10} = (17 \frac{3}{10})_8$

The following are examples of multiplication and division of octary fractions:

Multiplication: $\frac{3}{4} \times \frac{2}{13} = \frac{6}{13}$

Division: $\frac{5}{10} \div 3 \frac{1}{2}$

Using mixed numbers $\frac{5}{10} \times \frac{2}{7} = \frac{5}{34}$

Exercise: work the following in Octary system.

A. Addition:

$$\begin{array}{r} 3 \frac{4}{5} \\ 6 \frac{3}{12} \\ \hline \end{array}$$

$$\begin{array}{r} 5 \frac{5}{10} \\ 6 \frac{7}{20} \\ \hline \end{array}$$

$$\begin{array}{r} 14 \frac{4}{11} \\ 26 \frac{7}{14} \\ \hline \end{array}$$

$$\begin{array}{r} 38 \frac{1}{2} \\ 22 \frac{5}{10} \\ 16 \frac{3}{4} \\ \hline \end{array}$$

$$\begin{array}{r} 62 \frac{3}{17} \\ 53 \frac{5}{16} \\ 18 \frac{1}{2} \\ \hline \end{array}$$

B. Subtract:

$$\begin{array}{r} 3 \frac{5}{10} \\ 1 \frac{1}{2} \\ \hline \end{array}$$

$$\begin{array}{r} 16 \frac{4}{11} \\ 6 \frac{1}{3} \\ \hline \end{array}$$

$$\begin{array}{r} 42 \frac{1}{10} \\ 17 \frac{11}{24} \\ \hline \end{array}$$

$$\begin{array}{r} 45 \frac{3}{17} \\ 18 \frac{11}{12} \\ \hline \end{array}$$

$$\begin{array}{r} 31 \frac{4}{11} \\ 25 \frac{3}{4} \\ \hline \end{array}$$

C. Multiplication and Division:

$$3 \frac{4}{5} \times 6 \frac{5}{12} =$$

$$5 \frac{5}{10} \times 6 \frac{7}{20} =$$

$$4 \frac{3}{4} \times \frac{16}{23} =$$

$$2 \frac{5}{7} \times 12 \frac{1}{2} =$$

$$2 \frac{4}{11} \div 5 \frac{7}{17} =$$

$$3 \frac{5}{7} \div 1 \frac{5}{25} =$$

$$6 \frac{3}{4} \div 5 \frac{3}{14} =$$

$$7 \frac{1}{2} \div 6 \frac{3}{7} =$$

000192

Born 1917

OFFICE OF INSPECTOR
Visit of MARCH 1958-59
1959

PRO. Bernard Pleimann

Establishment Junipero Serra High, Gardena

PERSONAL

Age _____

Health GOOD - HEARING DEFICIENCY

Character _____

Practical Judgment _____

Family Spirit _____

Docility _____

BURSITIS;

EDUCATIONAL STATUS

Degrees Held _____

Studies in Progress: _____

Teaching

Subjects Now Teaching MATHEMATICS

Clock Hours Weekly _____

Class Preparation _____

Correcting Assignments _____

Ability as Teacher _____

Academic Results _____

Discipline _____

ZEAL

Interest in Students' Religious Formation _____

OTHER OCCUPATIONS

In Community _____

In School _____

Outside _____

GENERAL APPRECIATION

000193

Inspector

Pleimann (Brother) Bernard Thomas (S.M.) | **4/10/17 - Norwood, Ohio** | **Catholic** | **Part Time**
 FAMILY NAME FIRST MIDDLE DATE OF BIRTH PLACE RELIGION ENTRANCE STATUS MAJOR
175 Phelan Ave. LOCAL ADDRESS GUARDIAN **June 1934** RELATIONSHIP PREVIOUS COLLEGE ATTENDED HOME ADDRESS **Spring 1952** DEGREE GRANTED

Mt. St. John Prep., Dayton, Ohio | **June 1934** | **Spring 1952**
 SECONDARY SCHOOL DATE OF GRADUATION PREVIOUS COLLEGE ATTENDED DATE OF ADMISSION DATE OF DEGREE

| Entrance Credits | Spring 1952 | | | AT UN GR | | | PTS | | | AT UN GR | | | PTS | | |
|------------------|-------------|----|----|----------|----|----|-----|----|----|----------|----|----|-----|-----|--|
| | UN | AT | UN | AT | UN | GR | AT | UN | GR | PTS | AT | UN | GR | PTS | |
| ENGL. | Math 108 | 2 | 2 | A | 6 | | | | | | | | | | |
| | Math 115 | 3 | 3 | B | 6 | | | | | | | | | | |
| ALG. | Educ 111 | 2 | 2 | B | 4 | | | | | | | | | | |
| GEOM. | Educ 125 | 2 | 2 | A | 6 | | | | | | | | | | |
| SOC. SCI. | Educ 245 | 2 | 2 | A | 6 | | | | | | | | | | |
| LAB. SCI. | | | | | | | | | | | | | | | |
| CHEM. | Summer 1952 | | | | | | | | | | | | | | |
| PHYS. | Withdraw | | | | | | | | | | | | | | |
| LANG. | | | | | | | | | | | | | | | |
| TRIG. | | | | | | | | | | | | | | | |
| GEN. SCI. | | | | | | | | | | | | | | | |
| P.E./ROTC. | | | | | | | | | | | | | | | |
| COM. | | | | | | | | | | | | | | | |
| VOC. | | | | | | | | | | | | | | | |
| TOTALS: | | | | | | | | | | | | | | | |

GRADING SYSTEM: A, 100-93--B, 92-85--C, 84-78--D, 77-70 (Pass)--E, 69-60 (Cond.)--F, Below 60
 (Fail)--Inc., Incomplete--W, Withdrawn with permission, 1-99, Lower Division Courses--100-199, Upper
 Division--200-299, Graduate--300-399, Professional Level, Two semesters of 18 weeks and 6 week
 Summer Session per year.

This student is entitled to honorable dismissal. (Not an official transcript unless signed by Registrar
 and impressed with seal of University.) 128 units required for degree. completed. Date 5/13/52

Registrar *[Signature]* Date

405000

1935

Pleimann Bernard

1936

| | | | | | | |
|------------|-------|-------------|---|---|---|---|
| Eng. | 3 | Eng. | 2 | 2 | 3 | 3 |
| Hist. Mod. | 2 | Lat. | 2 | 2 | | |
| Amer. | 1 | Hist. | 3 | 3 | | |
| Alg. | 1 1/2 | Ethics | 2 | 2 | | |
| Geom. | 1 1/2 | Educ. | 2 | | 2 | 2 |
| Chem. | 1 | Sci. Ser. | 2 | | | |
| Phys. | 1 | Draw. | 2 | | | |
| Lat | 3 | Appl. | | 2 | | |
| Geom. | 2 | Logn. | | 2 | | |
| | | Mus. | | 2 | | |
| | | Geom. | | | 3 | 3 |
| | | Hist. Mod. | | | 2 | 2 |
| | | Trig. | | | 4 | |
| | | Chem. Gen. | | | 3 | 3 |
| | | Anal. Geom. | | | | 4 |

000195

MARIANIST PROVINCE OF THE PACIFIC
OFFICE OF INSTRUCTION
BOX 586 • SANTA CRUZ, CALIFORNIA

M E S S A G E

TO Bro. Bernard Pleiman, S.M.
St. Louis High School
Honolulu, Hawaii

DATE September 6, 1963

Dear Brother Bernard,

Kindly send me at your very earliest convenience the results of your summer courses with course title(s), credit hours, & grade.

Your cooperation is appreciated and your personal record in the provincial office will be up to date.

Maria duce,

Maurice Miller, S.M.
Bro. Maurice Miller, S.M.

R E P L Y

DATE Sept. 12, 1963

Math 221 Vector Geometry

4 units "1"

Math 220 Foundations of Geometry
and Trig

4 units "2"

Bro. Bernard Pleimann
Bro. Bernard Pleimann

000136